

Reactor® 2 Hydraulic Proportioning Systems

334945G
EN

Hydraulic, heated, plural component proportioner for spraying polyurethane foam and polyurea coatings.
Not for outdoor use. For professional use only.
Not approved for use in explosive atmospheres or hazardous (classified) locations.



Important Safety Instructions

Read all warnings and instructions in this manual. Save these instructions.

For model information, see page 9.

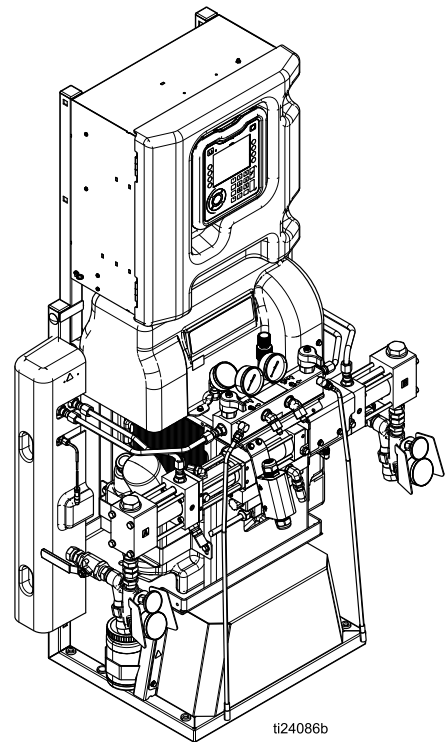







Contents









Warnings	3	Run Mode	40
Important Isocyanate Information	7	Startup	47
Models	9	Fluid Circulation	50
Approvals	15	Circulation Through Reactor	50
Accessories	15	Circulation Through Gun Manifold	51
Supplied Manuals	16	Spraying	52
Related Manuals	16	Spray Adjustments	53
Typical Installation, without circulation	17	Hose Control Modes	54
Typical Installation, with system fluid manifold to drum circulation	18	Enable Hose Resistance Mode	55
Typical Installation, with gun fluid manifold to drum circulation	19	Disable Hose Resistance Mode	55
Component Identification	20	Enable Hose Manual Mode	56
Advanced Display Module (ADM)	22	Disable Hose Manual Mode	56
ADM Display Details	24	Calibration Procedure	57
Navigating the Screens	24	Standby	58
Electrical Enclosure	27	Shutdown	59
Hydraulic Control Module (HCM)	28	Purge Air Procedure	60
Temperature Control Module (TCM) Cable Connections	29	Pressure Relief Procedure	62
Installation	30	Flushing	63
Mounting the System	30	Maintenance	64
Setup	30	Preventative Maintenance Schedule	64
Grounding	30	Proportioner Maintenance	64
General Equipment Guidelines	31	Flush Inlet Strainer Screen	65
Connect Power	32	Pump Lubrication System	66
Lubrication System Setup	33	Errors	67
Install Fluid Temperature Sensor	33	View Errors	67
Connect Heated Hose to Proportioner	33	Troubleshoot Errors	67
Advanced Display Module (ADM) Operation	34	Troubleshooting	68
Advanced Setup Screens	37	Error Codes and Troubleshooting	68
System 1	38	USB Data	69
System 2	38	Download Procedure	69
System 3	38	USB Logs	69
System 4	38	System Configuration Settings	70
Recipes	39	Custom Language File	71
Cellular Screen	39	Create Custom Language Strings	71
		Upload Procedure	71
		Performance Charts	72
		Dimensions	74
		Notes	75
		Technical Specifications	76
		Graco Extended Warranty	78







Warnings







The following warnings are for the setup, use, grounding, maintenance, and repair of this equipment. The exclamation point symbol alerts you to a general warning and the hazard symbols refer to procedure-specific risks. When these symbols appear in the body of this manual or on warning labels, refer back to these Warnings. Product-specific hazard symbols and warnings not covered in this section may appear throughout the body of this manual where applicable.

 WARNING	
 	<p>ELECTRIC SHOCK HAZARD</p> <p>This equipment must be grounded. Improper grounding, setup, or usage of the system can cause electric shock.</p> <ul style="list-style-type: none"> • Turn off and disconnect power at main switch before disconnecting any cables and before servicing or installing equipment. • Connect only to grounded power source. • All electrical wiring must be done by a qualified electrician and comply with all local codes and regulations. • Do not expose to rain. Store indoors.
 	<p>TOXIC FLUID OR FUMES</p> <p>Toxic fluids or fumes can cause serious injury or death if splashed in the eyes or on skin, inhaled or swallowed.</p> <ul style="list-style-type: none"> • Read Safety Data Sheet (SDS) for handling instructions and to know the specific hazards of the fluids you are using, including the effects of long-term exposure. • When spraying, servicing equipment, or when in the work area, always keep work area well ventilated and always wear appropriate personal protective equipment. See Personal Protective Equipment warnings in this manual. • Store hazardous fluid in approved containers, and dispose of it according to applicable guidelines.
	<p>PERSONAL PROTECTIVE EQUIPMENT</p> <p>Always wear appropriate personal protective equipment and cover all skin when spraying, servicing equipment, or when in the work area. Protective equipment helps prevent serious injury, including long-term exposure; inhalation of toxic fumes, mists or vapors; allergic reaction; burns; eye injury and hearing loss. This protective equipment includes but is not limited to:</p> <ul style="list-style-type: none"> • A properly fitting respirator, which may include a supplied-air respirator, chemically impermeable gloves, protective clothing and foot coverings as recommended by the fluid manufacturer and local regulatory authority. • Protective eyewear and hearing protection.

WARNING

    	<p>SKIN INJECTION HAZARD</p> <p>High-pressure fluid from dispensing device, hose leaks, or ruptured components will pierce skin. This may look like just a cut, but it is a serious injury that can result in amputation. Get immediate surgical treatment.</p> <ul style="list-style-type: none"> • Engage trigger lock when not spraying. • Do not point dispensing device at anyone or at any part of the body. • Do not put your hand over the fluid outlet. • Do not stop or deflect leaks with your hand, body, glove, or rag. • Follow the Pressure Relief Procedure when you stop dispensing and before cleaning, checking, or servicing equipment. • Tighten all fluid connections before operating the equipment. • Check hoses and couplings daily. Replace worn or damaged parts immediately.
   	<p>FIRE AND EXPLOSION HAZARD</p> <p>Flammable fumes, such as solvent and paint fumes, in work area can ignite or explode. Paint or solvent flowing through the equipment can cause static sparking. To help prevent fire and explosion:</p> <ul style="list-style-type: none"> • Use equipment only in well ventilated area. • Eliminate all ignition sources; such as pilot lights, cigarettes, portable electric lamps, and plastic drop cloths (potential static sparking). • Ground all equipment in the work area. See Grounding instructions. • Never spray or flush solvent at high pressure. • Keep work area free of debris, including solvent, rags and gasoline. • Do not plug or unplug power cords, or turn power or light switches on or off when flammable fumes are present. • Use only grounded hoses. • Hold gun firmly to side of grounded pail when triggering into pail. Do not use pail liners unless they are anti-static or conductive. • Stop operation immediately if static sparking occurs or you feel a shock. Do not use equipment until you identify and correct the problem. • Keep a working fire extinguisher in the work area.

 <h1 style="margin: 0;">WARNING</h1>	
  	<p>THERMAL EXPANSION HAZARD</p> <p>Fluids subjected to heat in confined spaces, including hoses, can create a rapid rise in pressure due to the thermal expansion. Over-pressurization can result in equipment rupture and serious injury.</p> <ul style="list-style-type: none"> • Open a valve to relieve the fluid expansion during heating. • Replace hoses proactively at regular intervals based on your operating conditions.
	<p>PRESSURIZED ALUMINUM PARTS HAZARD</p> <p>Use of fluids that are incompatible with aluminum in pressurized equipment can cause serious chemical reaction and equipment rupture. Failure to follow this warning can result in death, serious injury, or property damage.</p> <ul style="list-style-type: none"> • Do not use 1,1,1-trichloroethane, methylene chloride, other halogenated hydrocarbon solvents or fluids containing such solvents. • Many other fluids may contain chemicals that can react with aluminum. Contact your material supplier for compatibility.
 	<p>PLASTIC PARTS CLEANING SOLVENT HAZARD</p> <p>Many solvents can degrade plastic parts and cause them to fail, which could cause serious injury or property damage.</p> <ul style="list-style-type: none"> • Use only compatible water-based solvents to clean plastic structural or pressure-containing parts. • See Technical Data in this and all other equipment instruction manuals. Read fluid and solvent manufacturer's MSDSs and recommendations.

 <h1 style="margin: 0;">WARNING</h1>	
 	<p>EQUIPMENT MISUSE HAZARD</p> <p>Misuse can cause death or serious injury.</p> <ul style="list-style-type: none"> • Do not operate the unit when fatigued or under the influence of drugs or alcohol. • Do not exceed the maximum working pressure or temperature rating of the lowest rated system component. See Technical Data in all equipment manuals. • Use fluids and solvents that are compatible with equipment wetted parts. See Technical Data in all equipment manuals. Read fluid and solvent manufacturer's warnings. For complete information about your material, request MSDS from distributor or retailer. • Do not leave the work area while equipment is energized or under pressure. • Turn off all equipment and follow the Pressure Relief Procedure when equipment is not in use. • Check equipment daily. Repair or replace worn or damaged parts immediately with genuine manufacturer's replacement parts only. • Do not alter or modify equipment. Alterations or modifications may void agency approvals and create safety hazards. • Make sure all equipment is rated and approved for the environment in which you are using it. • Use equipment only for its intended purpose. Call your distributor for information. • Route hoses and cables away from traffic areas, sharp edges, moving parts, and hot surfaces. • Do not kink or over bend hoses or use hoses to pull equipment. • Keep children and animals away from work area. • Comply with all applicable safety regulations.
 	<p>MOVING PARTS HAZARD</p> <p>Moving parts can pinch, cut or amputate fingers and other body parts.</p> <ul style="list-style-type: none"> • Keep clear of moving parts. • Do not operate equipment with protective guards or covers removed. • Pressurized equipment can start without warning. Before checking, moving, or servicing equipment, follow the Pressure Relief Procedure and disconnect all power sources.
	<p>BURN HAZARD</p> <p>Equipment surfaces and fluid that is heated can become very hot during operation. To avoid severe burns:</p> <ul style="list-style-type: none"> • Do not touch hot fluid or equipment.

Important Isocyanate Information

Isocyanates (ISO) are catalysts used in two component materials.

Isocyanate Conditions

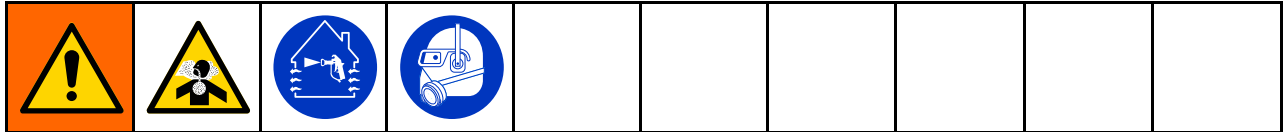



Spraying or dispensing fluids that contain isocyanates creates potentially harmful mists, vapors, and atomized particulates.



- Read and understand the fluid manufacturer’s warnings and Safety Data Sheet (SDS) to know specific hazards and precautions related to isocyanates.
- Use of isocyanates involves potentially hazardous procedures. Do not spray with this equipment unless you are trained, qualified, and have read and understood the information in this manual and in the fluid manufacturer’s application instructions and SDS.
- Use of incorrectly maintained or mis-adjusted equipment may result in improperly cured material, which could cause off gassing and offensive odors. Equipment must be carefully maintained and adjusted according to instructions in the manual.
- To prevent inhalation of isocyanate mists, vapors and atomized particulates, everyone in the work area must wear appropriate respiratory protection. Always wear a properly fitting respirator, which may include a supplied-air respirator. Ventilate the work area according to instructions in the fluid manufacturer’s SDS.
- Avoid all skin contact with isocyanates. Everyone in the work area must wear chemically impermeable gloves, protective clothing and foot coverings as recommended by the fluid manufacturer and local regulatory authority. Follow all fluid manufacturer recommendations, including those regarding handling of contaminated clothing. After spraying, wash hands and face before eating or drinking.
- Hazard from exposure to isocyanates continues after spraying. Anyone without appropriate personal protective equipment must stay out of the work area during application and after application for the time period specified by the fluid manufacturer. Generally this time period is at least 24 hours.
- Warn others who may enter work area of hazard from exposure to isocyanates. Follow the recommendations of the fluid manufacturer and local regulatory authority. Posting a placard such as the following outside the work area is recommended:



Material Self-Ignition

				
Some materials may become self-igniting if applied too thick. Read material manufacturer's warnings and SDS.				

Keep Components A and B Separate

				
Cross-contamination can result in cured material in fluid lines which could cause serious injury or damage to equipment. To prevent cross-contamination:				
<ul style="list-style-type: none">• Never interchange component A and component B wetted parts.• Never use solvent on one side if it has been contaminated from the other side.				

Changing Materials

NOTICE				
Changing the material types used in your equipment requires special attention to avoid equipment damage and downtime.				
<ul style="list-style-type: none">• When changing materials, flush the equipment multiple times to ensure it is thoroughly clean.• Always clean the fluid inlet strainers after flushing.• Check with your material manufacturer for chemical compatibility.• When changing between epoxies and urethanes or polyureas, disassemble and clean all fluid components and change hoses. Epoxies often have amines on the B (hardener) side. Polyureas often have amines on the B (resin) side.				

Moisture Sensitivity of Isocyanates

Exposure to moisture (such as humidity) will cause ISO to partially cure, forming small, hard, abrasive crystals that become suspended in the fluid. Eventually a film will form on the surface and the ISO will begin to gel, increasing in viscosity.

NOTICE				
Partially cured ISO will reduce performance and the life of all wetted parts.				
<ul style="list-style-type: none">• Always use a sealed container with a desiccant dryer in the vent, or a nitrogen atmosphere. Never store ISO in an open container.• Keep the ISO pump wet cup or reservoir (if installed) filled with appropriate lubricant. The lubricant creates a barrier between the ISO and the atmosphere.• Use only moisture-proof hoses compatible with ISO.• Never use reclaimed solvents, which may contain moisture. Always keep solvent containers closed when not in use.• Always lubricate threaded parts with an appropriate lubricant when reassembling.				

NOTE: The amount of film formation and rate of crystallization varies depending on the blend of ISO, the humidity, and the temperature.

Foam Resins with 245 fa Blowing Agents

Some foam blowing agents will froth at temperatures above 90 °F (33 °C) when not under pressure, especially if agitated. To reduce frothing, minimize preheating in a circulation system.

Models

Reactor 2 H-30 and H-30 Elite

Model	H-30 Model						H-30 Elite Model																	
	10 kW			15 kW			10 kW			15 kW														
Proportioner ★	17H031						17H032						17H131						17H132					
Maximum Fluid Working Pressure psi (MPa, bar)	2000 (14, 140)						2000 (14, 140)						2000 (14, 140)						2000 (14, 140)					
Approximate Output per Cycle (A+B) gal. (liter)	0.074 (0.28)						0.074 (0.28)						0.074 (0.28)						0.074 (0.28)					
Max Flow Rate lb/min (kg/min)	28 (12.7)						28 (12.7)						28 (12.7)						28 (12.7)					
Total System Load † (Watts)	17,960						23,260						17,960						23,260					
Configurable Voltage Phase (VAC, 50/60 Hz)	200– 240 1Ø	200– 240 3ØΔ	350– 415 3ØY	200– 240 1Ø	200– 240 3ØΔ	350– 415 3ØY	200– 240 1Ø	200– 240 3ØΔ	350– 415 3ØY	200– 240 1Ø	200– 240 3ØΔ	350– 415 3ØY	200– 240 1Ø	200– 240 3ØΔ	350– 415 3ØY	200– 240 1Ø	200– 240 3ØΔ	350– 415 3ØY						
Full Load Peak Current*	79	46	35	100	59	35	79	46	35	100	59	35	79	46	35	100	59	35						

Fusion® AP Package ✖ (Gun Part No.)	APH031 (246102)	AHH031 (246102)	APH032 (246102)	AHH032 (246102)	APH131 (246102)	AHH131 (246102)	APH132 (246102)	AHH132 (246102)
Fusion® CS Package ✖ (Gun Part No.)	CSH031 (CS02RD)	CHH031 (CS02RD)	CSH032 (CS02RD)	CHH032 (CS02RD)	CSH131 (CS02RD)	CHH131 (CS02RD)	CSH132 (CS02RD)	CHH132 (CS02RD)
Probler P2 Package ✖ (Gun Part No.)	P2H031 (GCP2R2)	PHH031 (GCP2R2)	P2H032 (GCP2R2)	PHH032 (GCP2R2)	P2H131 (GCP2R2)	PHH131 (GCP2R2)	P2H132 (GCP2R2)	PHH132 (GCP2R2)
Heated Hose 50 ft (15 m) 24K240 (scuff guard) 24Y240 (Xtreme-wrap)	24K240 Qty: 1	24K240 Qty: 5	24K240 Qty: 1	24K240 Qty: 5	24Y240 Qty: 1	24Y240 Qty: 5	24Y240 Qty: 1	24Y240 Qty: 5
Heated Whip Hose 10 ft (3 m)	246050		246050		246050		246050	
Ratio Monitoring					✓		✓	
Fluid Inlet Sensors (2)					✓		✓	

* Full load amps with all devices operating at maximum capabilities. Fuse requirements at various flow rates and mix chamber sizes may be less.

† Total system watts used by system, based on maximum heated hose length for each unit.

- H-30 series: 310 ft (94.5 m) maximum heated hose length, including whip hose.

★ See [Approvals, page 15](#).

✖ Packages include gun, heated hose, and whip hose. Elite packages also include ratio monitoring and fluid inlet sensors. All Elite hose and gun system packages include Xtreme-Wrap™ 50 ft (15 m) heated hose. For part numbers, see [Accessories, page 15](#).

Voltage Configurations Key	
Ø	PHASE
Δ	DELTA
Y	WYE

Reactor 2 H-40 and H-40 Elite, 200–240V

Model	H-40 Model		H-40 Elite Model	
	15 kW	20 kW	15 kW	20 kW
Proportioner ★	17H043	17H044	17H143	17H144
Maximum Fluid Working Pressure psi (MPa, bar)	2000 (14, 140)	2000 (14, 140)	2000 (14, 140)	2000 (14, 140)
Approximate Output per Cycle (A+B) gal. (liter)	0.063 (0.24)	0.063 (0.24)	0.063 (0.24)	0.063 (0.24)
Max Flow Rate lb/min (kg/min)	45 (20)	45 (20)	45 (20)	45 (20)
Total System Load † (Watts)	26,600	31,700	26,600	31,700
Voltage Phase (VAC 50/60 Hz)	200–240 3ØΔ	200–240 3ØΔ	200–240 3ØΔ	200–240 3ØΔ
Full Load Peak Current*	71	95	71	95

Fusion® AP Package ✖ (Gun Part No.)	APH043 (246102)	AHH043 (246102)	APH044 (246102)	AHH044 (246102)	APH143 (246102)	AHH143 (246102)	APH144 (246102)	AHH144 (246102)
Fusion® CS Package ✖ (Gun Part No.)	CSH043 (CS02RD)	CHH043 (CS02RD)	CSH044 (CS02RD)	CHH044 (CS02RD)	CSH143 (CS02RD)	CHH143 (CS02RD)	CSH144 (CS02RD)	CHH144 (CS02RD)
Probler P2 Package ✖ (Gun Part No.)	P2H043 (GCP2R2)	PHH043 (GCP2R2)	P2H044 (GCP2R2)	PHH044 (GCP2R2)	P2H143 (GCP2R2)	PHH143 (GCP2R2)	P2H144 (GCP2R2)	PHH144 (GCP2R2)
Heated Hose 50 ft (15 m) 24K240 (scuff guard) 24Y240 (Xtreme-wrap)	24K240	24K240	24K240	24K240	24Y240	24Y240	24Y240	24Y240
	Qty: 1	Qty: 6	Qty: 1	Qty: 6	Qty: 1	Qty: 6	Qty: 1	Qty: 6
Heated Whip Hose 10 ft (3 m)	246050		246050		246050		246050	
Fluid Inlet Sensors (2)					✓		✓	

* Full load amps with all devices operating at maximum capabilities. Fuse requirements at various flow rates and mix chamber sizes may be less.

† Total system watts used by system, based on maximum heated hose length for each unit.

- H-40 series: 410 ft (125 m) maximum heated hose length, including whip hose.

★ See [Approvals, page 15](#).

✖ Packages include gun, heated hose, and whip hose. Elite packages also include ratio monitoring and fluid inlet sensors. All Elite hose and gun system packages include Xtreme-Wrap™ 50 ft (15 m) heated hose. For part numbers, see [Accessories, page 15](#).

Voltage Configurations Key	
Ø	PHASE
Δ	DELTA
Y	WYE

Reactor 2 H-40 and H-40 Elite, 350–415V (Continued)

Model	H-40 Model		H-40 Elite Model	
	15 kW	20 kW	15 kW	20 kW
Proportioner ★	17H045	17H046	17H145	17H146
Maximum Fluid Working Pressure psi (MPa, bar)	2000 (14, 140)	2000 (14, 140)	2000 (14, 140)	2000 (14, 140)
Approximate Output per Cycle (A+B) gal. (liter)	0.063 (0.24)	0.063 (0.24)	0.063 (0.24)	0.063 (0.24)
Max Flow Rate lb/min (kg/min)	45 (20)	45 (20)	45 (20)	45 (20)
Total System Load † (Watts)	26,600	31,700	26,600	31,700
Voltage Phase (VAC 50/60 Hz)	350–415 3ØY	350–415 3ØY	350–415 3ØY	350–415 3ØY
Full Load Peak Current*	41	52	41	52

Fusion® AP Package ★ (Gun Part No.)	APH045 (246102)	AHH045 (246102)	APH046 (246102)	AHH046 (246102)	APH145 (246102)	AHH145 (246102)	APH146 (246102)	AHH146 (246102)
Fusion® CS Package ★ (Gun Part No.)	CSH045 (CS02RD)	CHH045 (CS02RD)	CSH046 (CS02RD)	CHH046 (CS02RD)	CSH145 (CS02RD)	CHH145 (CS02RD)	CSH146 (CS02RD)	CHH146 (CS02RD)
Probler P2 Package ★ (Gun Part No.)	P2H045 (GCP2R2)	PHH045 (GCP2R2)	P2H046 (GCP2R2)	PHH046 (GCP2R2)	P2H145 (GCP2R2)	PHH145 (GCP2R2)	P2H146 (GCP2R2)	PHH146 (GCP2R2)
Heated Hose 50 ft (15 m) 24K240 (scuff guard) 24Y240 (Xtreme-wrap)	24K240	24K240	24K240	24K240	24Y240	24Y240	24Y240	24Y240
	Qty: 1	Qty: 6	Qty: 1	Qty: 6	Qty: 1	Qty: 6	Qty: 1	Qty: 6
Heated Whip Hose 10 ft (3 m)	246050		246050		246050		246050	
Ratio Monitoring					✓		✓	
Fluid Inlet Sensors (2)					✓		✓	

* Full load amps with all devices operating at maximum capabilities. Fuse requirements at various flow rates and mix chamber sizes may be less.

† Total system watts used by system, based on maximum heated hose length for each unit.

- H-40 series: 410 ft (125 m) maximum heated hose length, including whip hose.

★ See [Approvals, page 15](#).

✘ Packages include gun, heated hose, and whip hose. Elite packages also include ratio monitoring and fluid inlet sensors. All Elite hose and gun system packages include Xtreme-Wrap™ 50 ft (15 m) heated hose. For part numbers, see [Accessories, page 15](#).

Voltage Configurations Key	
Ø	PHASE
Δ	DELTA
Y	WYE

Reactor 2 H-50 and H-50 Elite

Model	H-50 Model		H-50 Elite Model	
	20 kW	20 kW	20 kW	20 kW
Proportioner ★	17H053	17H056	17H153	17H156
Maximum Fluid Working Pressure psi (MPa, bar)	2000 (14, 140)	2000 (14, 140)	2000 (14, 140)	2000 (14, 140)
Approximate Output per Cycle (A+B) gal. (liter)	0.074 (0.28)	0.074 (0.28)	0.074 (0.28)	0.074 (0.28)
Max Flow Rate lb/min (kg/min)	52 (24)	52 (24)	52 (24)	52 (24)
Total System Load † (Watts)	31,700	31,700	31,700	31,700
Voltage Phase (VAC, 50/60 Hz)	200–240 3ØΔ	350–415 3ØY	200–240 3ØΔ	350–415 3ØY
Full Load Peak Current*	95	52	95	52

Fusion® AP Package ✖ (Gun Part No.)	APH053 (246102)	AHH053 (246102)	APH056 (246102)	AHH056 (246102)	APH153 (246102)	AHH153 (246102)	APH156 (246102)	AHH156 (246102)
Fusion® CS Package ✖ (Gun Part No.)	CSH053 (CS02RD)	CHH053 (CS02RD)	CSH056 (CS02RD)	CHH056 (CS02RD)	CSH153 (CS02RD)	CHH153 (CS02RD)	CSH156 (CS02RD)	CHH156 (CS02RD)
Probler P2 Package ✖ (Gun Part No.)	P2H053 (GCP2R2)	PHH053 (GCP2R2)	P2H056 (GCP2R2)	PHH056 (GCP2R2)	P2H153 (GCP2R2)	PHH153 (GCP2R2)	P2H156 (GCP2R2)	PHH156 (GCP2R2)
Heated Hose 50 ft (15 m) 24K240 (scuff guard) 24Y240 (Xtreme-wrap)	24K240	24K240	24K240	24K240	24Y240	24Y240	24Y240	24Y240
	Qty: 1	Qty: 6	Qty: 1	Qty: 6	Qty: 1	Qty: 6	Qty: 1	Qty: 6
Heated Whip Hose 10 ft (3 m)	246050		246050		246050		246050	
Ratio Monitoring					✓		✓	
Fluid Inlet Sensors (2)					✓		✓	

* Full load amps with all devices operating at maximum capabilities. Fuse requirements at various flow rates and mix chamber sizes may be less.

† Total system watts used by system, based on maximum heated hose length for each unit.

- H-50 series: 410 ft (125 m) maximum heated hose length, including whip hose.

★ See [Approvals, page 15](#).

✖ Packages include gun, heated hose, and whip hose. Elite packages also include ratio monitoring and fluid inlet sensors. All Elite hose and gun system packages include Xtreme-Wrap™ 50 ft (15 m) heated hose. For part numbers, see [Accessories, page 15](#).

Voltage Configurations Key	
Ø	PHASE
Δ	DELTA
Y	WYE

Reactor 2 H-XP2 and H-XP2 Elite

Model	H-XP2 Model			H-XP2 Elite Model		
	15 kW			15kW		
Proportioner ★	17H062			17H162		
Maximum Fluid Working Pressure psi (MPa, bar)	3500 (24.1, 241)			3500 (24.1, 241)		
Approximate Output per Cycle (A+B) gal. (liter)	0.042 (0.16)			0.042 (0.16)		
Max Flow Rate gpm (lpm)	1.5 (5.7)			1.5 (5.7)		
Total System Load † (Watts)	23,260			23,260		
Voltage Phase (VAC, 50/60 Hz)	200–240 1Ø	200–240 3ØΔ	350–415 3ØY	200–240 1Ø	200–240 3ØΔ	350–415 3ØY
Full Load Peak Current*	100	59	35	100	59	35
Fusion® AP Package ✖ (Gun Part No.)	APH062 (246101)	AHH062 (246101)	APH162 (246101)	AHH162 (246101)		
Probler P2 Package ✖ (Gun Part No.)	P2H062 (GCP2R1)	PHH062 (GCP2R1)	P2H162 (GCP2R1)	PHH162 (GCP2R1)		
Heated Hose 50 ft (15 m)	24K241	24K241	24Y241	24K241		
	Qty. 1	Qty. 5	Qty. 1	Qty. 5		
Heated Whip Hose 10 ft (3 m)	246055			246055		
Fluid Inlet Sensors (2)				✓		
Ratio Monitoring				✓		

- * Full load amps with all devices operating at maximum capabilities. Fuse requirements at various flow rates and mix chamber sizes may be less.
- † Total system watts used by system, based on maximum heated hose length for each unit.
 - H-XP2 series: 310 ft (94.5 m) maximum heated hose length, including whip hose.

- ★ See [Approvals, page 15](#).
- ✖ Packages include gun, heated hose, and whip hose. Elite packages also include fluid inlet sensors. All Elite hose and gun system packages include Xtreme-Wrap™ 50 ft (15 m) heated hose. For part numbers, see [Accessories, page 15](#).

Voltage Configurations Key	
Ø	PHASE
Δ	DELTA
Y	WYE

Reactor 2 H-XP3 and H-XP3 Elite

Model	H-XP3 Model		H-XP3 Elite Model	
	20 kW	20 kW	20 kW	20 kW
Proportioner ★	17H074	17H076	17H174	17H176
Maximum Fluid Working Pressure psi (MPa, bar)	3500 (24.1, 241)	3500 (24.1, 241)	3500 (24.1, 241)	3500 (24.1, 241)
Approximate Output per Cycle (A+B) gal. (liter)	0.042 (0.16)	0.042 (0.16)	0.042 (0.16)	0.042 (0.16)
Max Flow Rate gpm (lpm)	2.8 (10.6)	2.8 (10.6)	2.8 (10.6)	2.8 (10.6)
Total System Load † (Watts)	31,700	31,700	31,700	31,700
Voltage Phase (VAC 50/60 Hz)	200-240 3ØΔ	350-415 3ØY	200-240 3ØΔ	350-415 3ØY
Full Load Peak Current*	95	52	95	52

Fusion® AP Package ✖ (Gun Part No.)	APH074 (246102)	AHH074 (246102)	APH076 (246102)	AHH076 (246102)	APH174 (246102)	AHH174 (246102)	APH176 (246102)	AHH176 (246102)
Probler P2 Package ✖ (Gun Part No.)	P2H074 (GCP2R2)	PHH074 (GCP2R2)	P2H076 (GCP2R2)	PHH076 (GCP2R2)	P2H174 (GCP2R2)	PHH174 (GCP2R2)	P2H176 (GCP2R2)	PHH176 (GCP2R2)
Heated Hose 50 ft (15 m) 24K240 (scuff guard) 24Y240 (Xtreme-wrap)	24K241 Qty: 1	24K241 Qty: 6	24K241 Qty: 1	24K241 Qty: 6	24Y241 Qty: 1	24Y241 Qty: 6	24Y241 Qty: 1	24Y241 Qty: 6
Heated Whip Hose 10 ft (3 m)	246055		246055		246055		246055	
Fluid Inlet Sensors (2)					✓		✓	
Ratio Monitoring					✓		✓	

* Full load amps with all devices operating at maximum capabilities. Fuse requirements at various flow rates and mix chamber sizes may be less.

† Total system watts used by system, based on maximum heated hose length for each unit.

- H-XP3 series: 410 ft (125 m) maximum heated hose length, including whip hose.

★ See [Approvals, page 15](#).

✖ Packages include gun, heated hose, and whip hose. Elite packages also include fluid inlet sensors. All Elite hose and gun system packages include Xtreme-Wrap™ 50 ft (15 m) heated hose. For part numbers, see [Accessories, page 15](#).

Voltage Configurations Key	
Ø	PHASE
Δ	DELTA
Y	WYE

Approvals

Intertek approvals apply to proportioners without hoses.

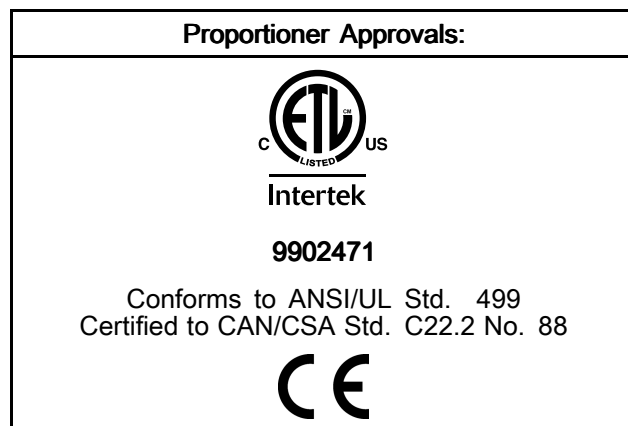

Accessories

Kit	Description
24U315	Air Manifold (4 outlets)
17G340	Caster Kit
17F837	Inlet Sensor Kit
16X521	Graco InSite Extension Cable 24.6 ft (7.5 m)
24N449	50 ft (15 m) CAN Cable (for remote display module)
24K207	Fluid Temperature Sensor (FTS) with RTD
24U174	Remote Display Module Kit
15V551	ADM Protective Covers (10 pack)
15M483	Remote Display Module Protective Covers (10 pack)
24M174	Drum Level Sticks
121006	150 ft (45 m) CAN Cable (for remote display module)
24N365	RTD Test Cables (to aide resistance measurements)
17F838	Elite Kit
24N748	Ratio Monitoring Kit
*979200	Integrated PowerStation, Tier 4 Final, no air
*979201	Integrated PowerStation, Tier 4 Final, 20 cfm
*979202	Integrated PowerStation, Tier 4 Final, 35 cfm

* **NOTE:** The Integrated PowerStation is only compatible with Reactor 2 H-30 and H-XP2 proportioning systems.

Supplied Manuals

The following manuals are shipped with the Reactor 2 Hydraulic. Refer to these manuals for detailed equipment information.

Manual	Description
334945	Reactor 2 Hydraulic Proportioning Systems Operation Manual
334005	Reactor 2 Hydraulic Proportioning Systems Shutdown Quick Guide
334006	Reactor 2 Hydraulic Proportioning Systems Startup Quick Guide

Related Manuals

The following manuals (English) are for accessories used with the Reactor 2 Hydraulic.

System Manuals	
334946	Reactor 2 Hydraulic Proportioner, Repair-Parts
Displacement Pump Manual	
3A3085	Pump, Repair-Parts
Feed System Manuals	
309852	Circulation and Return Tube Kit, Instructions-Parts
309815	Feed Pump Kits, Instructions-Parts
309827	Feed Pump Air Supply Kit, Instructions-Parts
Spray Gun Manuals	
309550	Fusion™ AP Gun, Instructions-Parts
312666	Fusion™ CS Gun, Instructions-Parts
313213	Probler® P2 Gun, Instructions-Parts
Accessory Manuals	
309572	Heated Hose, Instructions-Parts
3A3009	Inlet Sensor Kit, Instructions-Parts
3A1907	Remote Display Module Kit, Instructions-Parts
332735	Air Manifold Kit, Instructions-Parts
3A3010	Caster Kit, Instructions-Parts
3A6738	Ratio Monitoring Retrofit Kit, Instructions-Parts
3A3084	Elite Kit, Instructions-Parts
3A6335	Integrated PowerStation, Instructions

Manuals are available at www.graco.com.

Typical Installation, without circulation

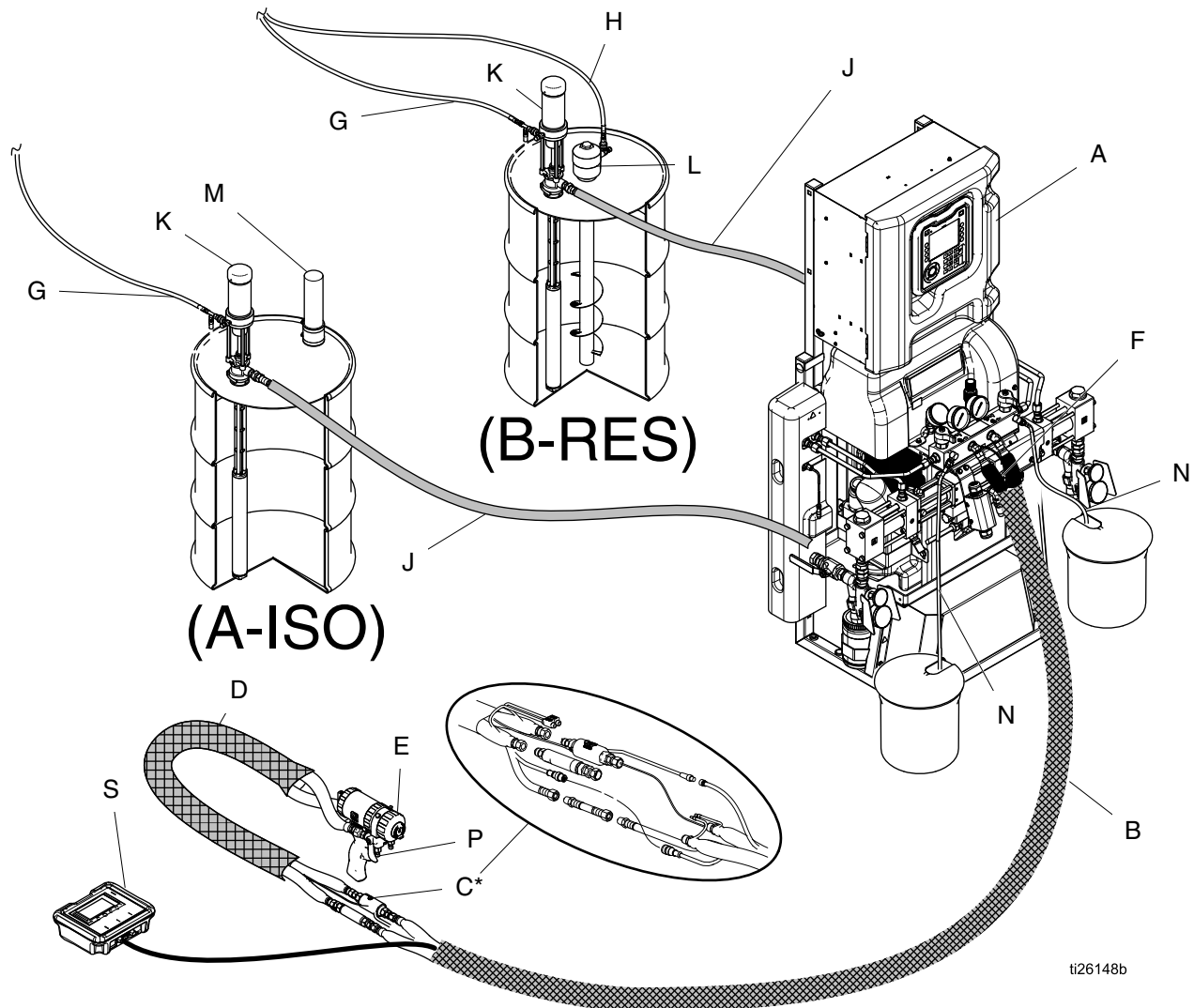

Figure 1

* Shown exposed for clarity. Wrap with tape during operation.

- | | | | |
|---|--------------------------------|---|--------------------------------------|
| A | Reactor Proportioner | J | Fluid Supply Lines |
| B | Heated Hose | K | Feed Pumps |
| C | Fluid Temperature Sensor (FTS) | L | Agitator |
| D | Heated Whip Hose | M | Desiccant Dryer |
| E | Fusion Spray Gun | N | Bleed Lines |
| F | Gun Air Supply Hose | P | Gun Fluid Manifold (part of gun) |
| G | Feed Pump Air Supply Lines | S | Remote Display Module Kit (optional) |
| H | Agitator Air Supply Line | | |

Typical Installation, with system fluid manifold to drum circulation

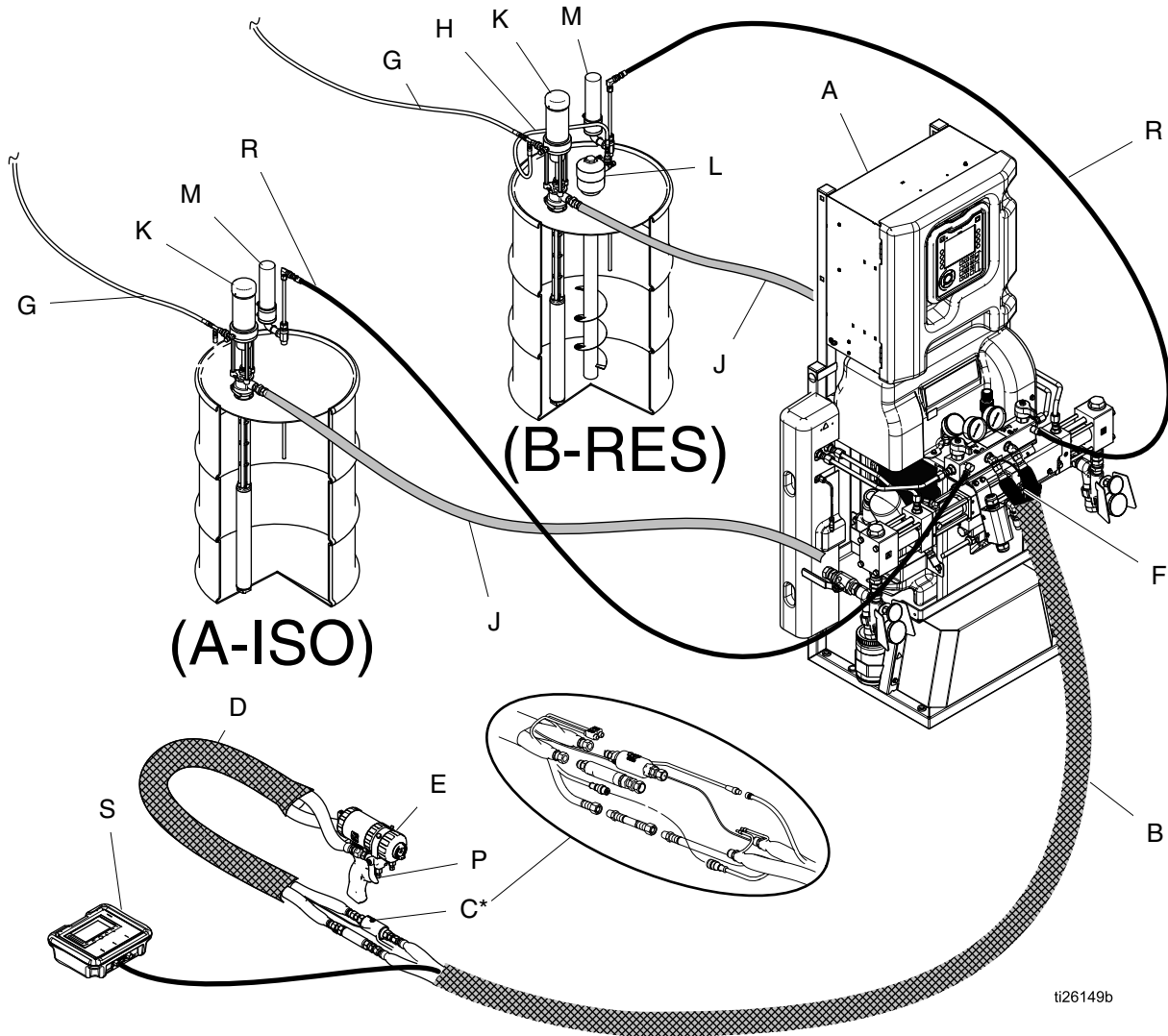

Figure 2

* Shown exposed for clarity. Wrap with tape during operation.

- | | | | |
|---|--------------------------------|---|----------------------------------|
| A | Reactor Proportioner | J | Fluid Supply Lines |
| B | Heated Hose | K | Feed Pumps |
| C | Fluid Temperature Sensor (FTS) | L | Agitator |
| D | Heated Whip Hose | M | Desiccant Dryer |
| E | Fusion Spray Gun | P | Gun Fluid Manifold (part of gun) |
| F | Gun Air Supply Hose | R | Recirculation Lines |
| G | Feed Pump Air Supply Lines | S | Remote Display Module (optional) |
| H | Agitator Air Supply Line | | |

Typical Installation, with gun fluid manifold to drum circulation

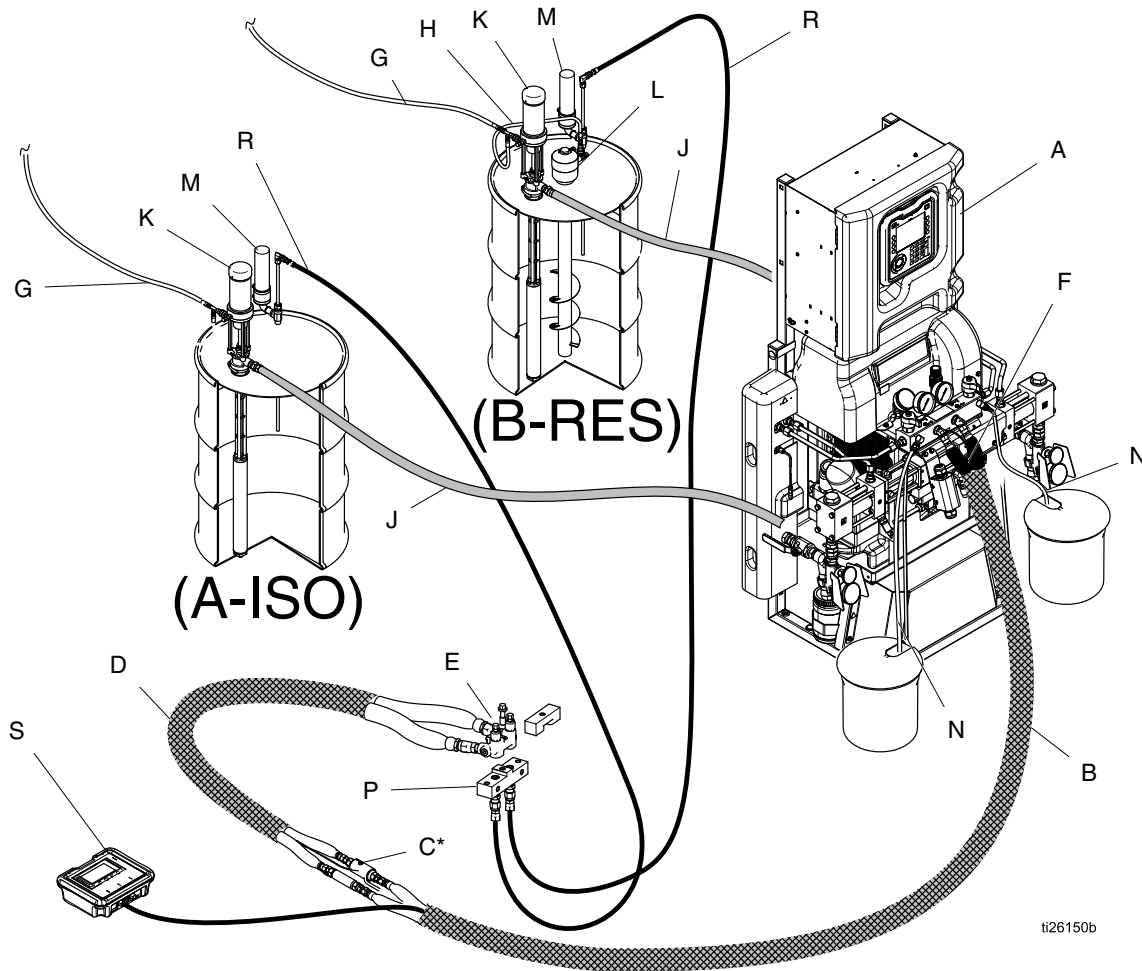

Figure 3

* Shown exposed for clarity. Wrap with tape during operation.

- | | | | |
|----|--------------------------------|---|----------------------------------|
| A | Reactor Proportioner | J | Fluid Supply Lines |
| B | Heated Hose | K | Feed Pumps |
| C | Fluid Temperature Sensor (FTS) | L | Agitator |
| CK | Circulation Block (accessory) | M | Desiccant Dryer |
| D | Heated Whip Hose | N | Bleed Lines |
| F | Gun Air Supply Hose | P | Gun Fluid Manifold (part of gun) |
| G | Feed Pump Air Supply Lines | R | Recirculation Lines |
| H | Agitator Air Supply Line | S | Remote Display Module (optional) |

Component Identification

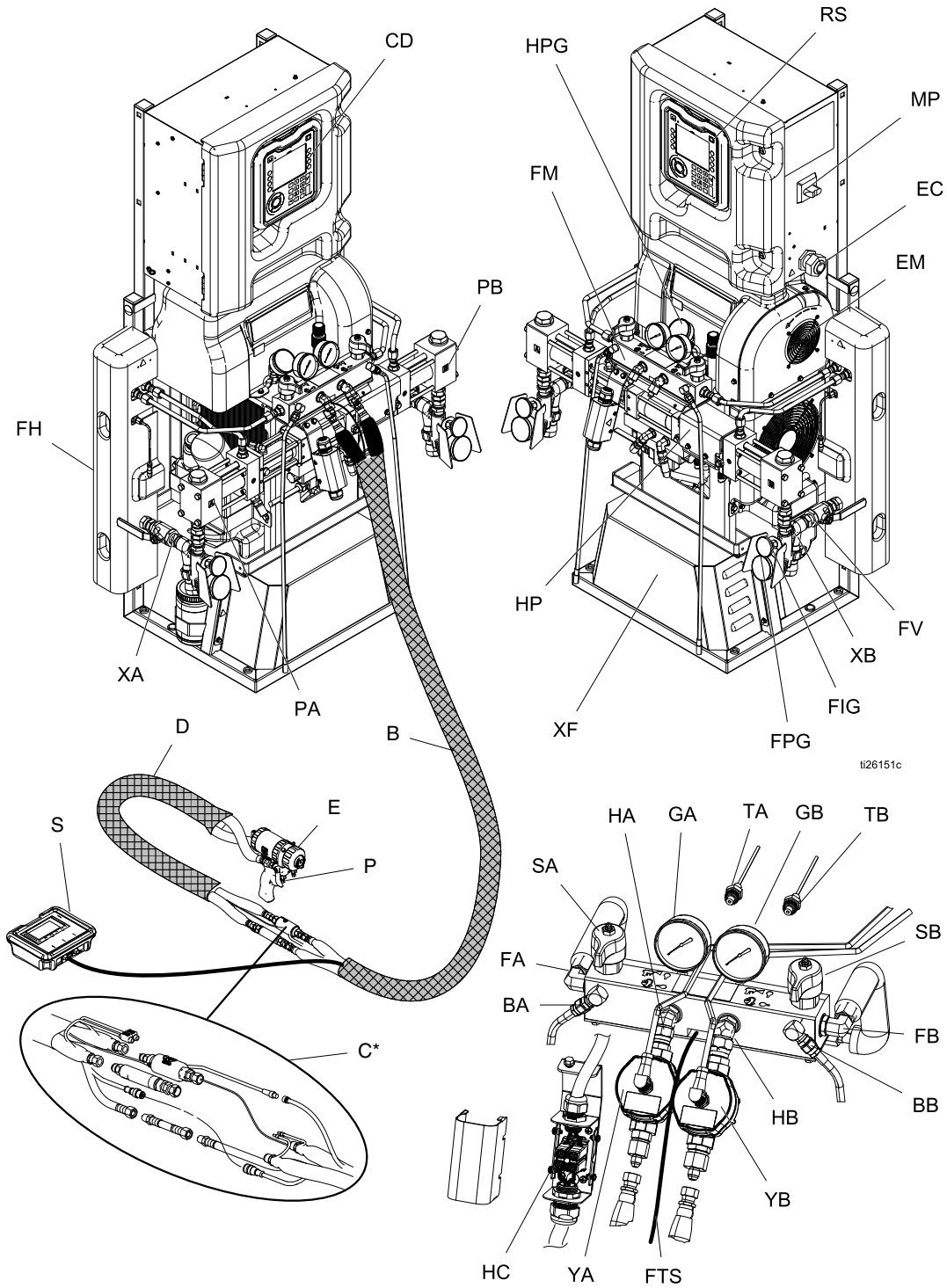

Figure 4

Key

BA	ISO Side Pressure Relief Outlet	PB	RES Side Pump
BB	RES Side Pressure Relief Outlet	RS	Red Stop Button
CD	Advanced Display Module (ADM)	S	Remote Display Module (optional)
EC	Electrical Cord Strain Relief	SA	ISO Side PRESSURE RELIEF/SPRAY Valve
EM	Electric Motor (behind shroud)	SB	RES Side PRESSURE RELIEF/SPRAY Valve
FA	ISO Side Fluid Manifold Inlet	TA	ISO Side Pressure Transducer (behind gauge GA)
FB	RES Side Fluid Manifold Inlet	TB	RES Side Pressure Transducer (behind gauge GB)
FH	Fluid Heater (behind shroud)	XA	Fluid Inlet Sensor (ISO side, Elite models only)
FM	Reactor Fluid Manifold	XB	Fluid Inlet Sensor (RES side, Elite models only)
FV	Fluid Inlet Valve (RES side shown)	XF	Heated Hose Transformer (behind cover)
GA	ISO Side Pressure Gauge	YA	Flow Meter (ISO side, Elite models only)
GB	RES Side Pressure Gauge	YB	Flow Meter (Resin side, Elite models only)
HA	ISO Side Hose Connection	FPG	Fluid Inlet Valve Pressure Gauge
HB	RES Side Hose Connection	FTG	Fluid Inlet Valve Temperature Gauge
HC	Heated Hose Electrical Junction Box	FTS	FTS Connection
HP	Hydraulic Driver (behind shroud)	HPG	Hydraulic Pressure Gauge
MP	Main Power Switch		
PA	ISO Side Pump		

Advanced Display Module (ADM)

The ADM display shows graphical and text information related to setup and spray operations.









Figure 5 ADM Front View

t22631a

NOTICE

To prevent damage to the soft key buttons, do not press buttons with sharp objects such as pens, plastic cards, or fingernails.

Table 1 : ADM Keys and Indicators

Key	Function
 Startup / Shutdown Key and Indicator	Press to startup or shutdown the system.
 Stop	Press to stop all proportioner processes. This is not a safety or emergency stop.
 Soft Keys	Press to select the specific screen or operation shown on the display directly next to each key.
 Navigation Keys	<ul style="list-style-type: none"> • <i>Left/Right Arrows:</i> Use to move from screen to screen. • <i>Up/Down Arrows:</i> Use to move among fields on a screen, items on a drop-down menu, or multiple screens within a function.
Numeric Keypad	Use to input values.
 Cancel	Use to cancel a data entry field. Also used to return to Home screen.
 Setup	Press to enter or exit Setup mode.
 Enter	Press to choose a field to update, to make a selection, to save a selection or value, to enter a screen, or to acknowledge an event.

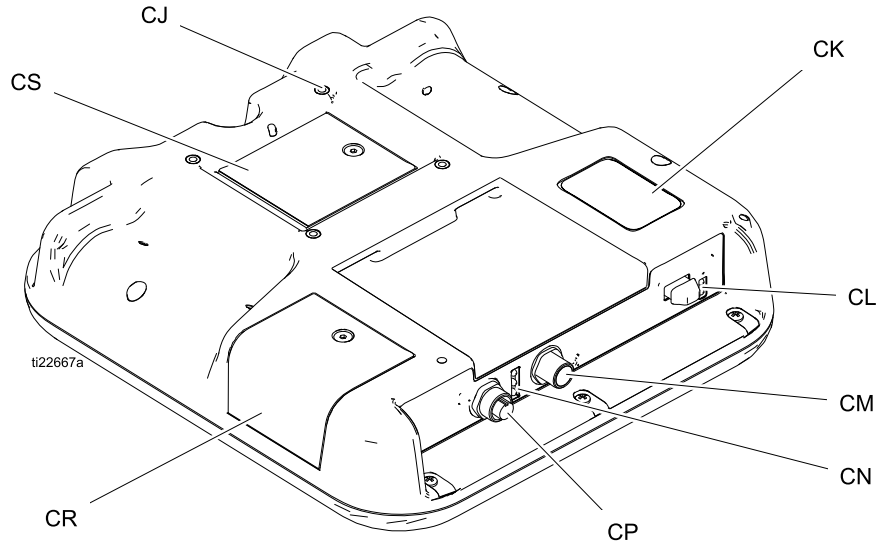



Figure 6 ADM Back View

CJ	Flat Panel Mount (VESA 100)
CK	Model and Serial Number
CL	USB Port and Status LEDs
CM	CAN Communication Cable Connection
CN	Module Status LEDs
CP	Accessory Cable Connection
CR	Token Access Cover
CS	Backup Battery Access Cover

Table 2 ADM LED Status Descriptions

LED	Conditions	Description
System Status 	Green Solid	Run Mode, System On
	Green Flashing	Setup Mode, System On
	Yellow Solid	Run Mode, System Off
	Yellow Flashing	Setup Mode, System Off
USB Status (CL)	Green Flashing	Data recording in progress
	Yellow Solid	Downloading information to USB
	Green and Yellow Flashing	ADM is busy, USB cannot transfer information when in this mode
ADM Status (CN)	Green Solid	Power applied to module
	Yellow Solid	Active Communication
	Red Steady Flashing	Software upload from token in progress
	Red Random Flashing or Solid	Module error exists

ADM Display Details

Power Up Screen

The following screen appears when the ADM is powered up. It remains on while the ADM runs through initialization and establishes communication with other modules in the system.



Menu Bar

The menu bar appears at the top of each screen. (The following image is only an example.)



Date and Time

The date and time are always displayed in one of the following formats. The time is always displayed as a 24-hour clock.

- DD/MM/YY HH:MM
- YY/MM/DD HH:MM
- MM/DD/YY HH:MM

Arrows

The left and right arrows indicate screen navigation.

Screen Menu

The screen menu indicates the currently active screen, which is highlighted. It also indicates the associated screens that are available by scrolling left and right.

System Mode

The current system mode is displayed at the lower left of the menu bar.

System Errors

The current system error is displayed in the middle of the menu bar. There are four possibilities:

Icon	Function
No Icon	No information or no error has occurred
	Advisory
	Deviation
	Alarm

See [Troubleshoot Errors, page 67](#) for more information.

Status

The current system status is displayed at the lower right of the menu bar.

Navigating the Screens

There are two sets of screens:

- **Run Screens** – control spraying operations and display system status and data.
- **Setup Screens** – control system parameters and advanced features.

Press on any Run screen to enter the Setup screens. If the system has a password lock, the Password screen displays. If the system is not locked (password is set to 0000), System screen 1 displays.







Press on any Setup screen to return to the Home screen.



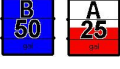

Press the Enter soft key to activate the editing function on any screen.

Press the Exit soft key to exit any screen.

Use the other soft keys to select the function adjacent to them.

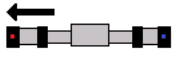
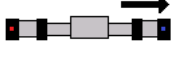
Icons

Icon	Function
	Component A
	Component B
	Estimated Supply Material
	Pressure
	Cycle Counter (press and hold)
	Advisory. See Troubleshoot Errors, page 67 for more information.
	Deviation. See Troubleshoot Errors, page 67 for more information.









Icon	Function
	Alarm. See Troubleshoot Errors, page 67 for more information.
	Pump Moving Left
	Pump Moving Right
	Hose Temperature in Hose FTS Mode
	Hose Temperature in Hose Resistance Mode
	Hose Amps in Manual Mode













Soft Keys

Icons next to the soft keys indicate which mode or action is associated with each soft key. Soft keys that do not have an icon next to them are not active in the current screen.

NOTICE

To prevent damage to the soft key buttons, do not press buttons with sharp objects such as pens, plastic cards, or fingernails.

Icon	Function
	Start Proportioner
	Stop Proportioner
	Turn on or off the specified heat zone.
	Park pump
	Reset Cycle Counter (press and hold)
	Select Recipe
	Search
	Move Cursor Left One Character
	Move Cursor Right One Character

Icon	Function
	Toggle between upper-case, lower-case, and numbers and special characters.
	Backspace
	Cancel
	Clear
	Troubleshoot Selected Error
	Increase value
	Decrease value
	Next screen
	Previous screen
	Return to first screen
	Calibrate
	Continue

Electrical Enclosure

H-40, H-50, H-XP3

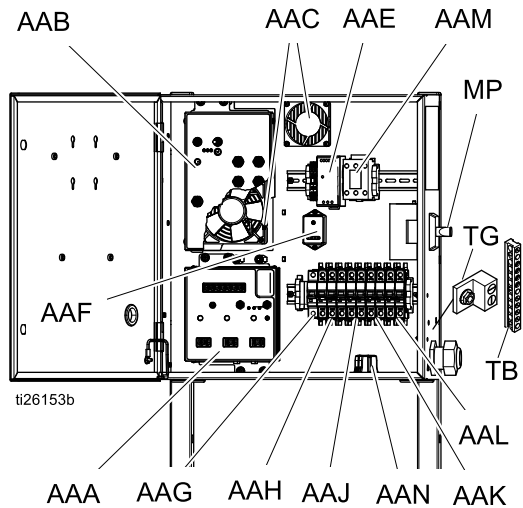

H-30, H-XP2

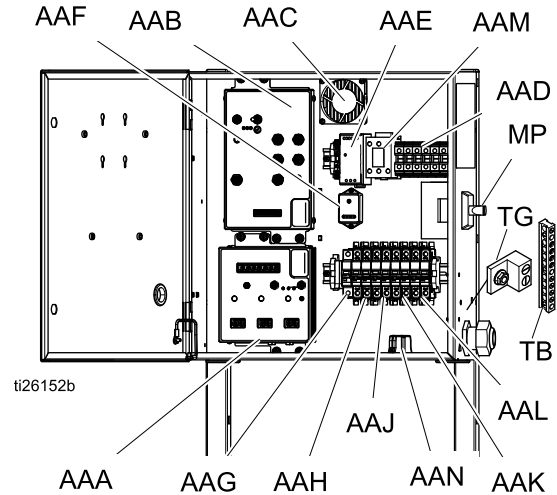

- AAA Temperature Control Module (TCM)
- AAB Hydraulic Control Module (HCM)
- AAC Enclosure Fan(s)
- AAD Wiring Terminal Blocks (H-30/H-XP2 only)
- AAE Power Supply
- AAF Sacrificial Surge Protector (SSP)
- AAG Hose Breaker
- AAH Motor Breaker
- AAJ A Side Heat Breaker
- AAK B Side Heat Breaker
- AAL Hose Transformer Breaker
- AAM Motor Contactor
- AAN TB21 Terminal Block (if equipped)
- MP Main Power Switch
- TB Terminal Bus
- TG Terminal Ground

Hydraulic Control Module (HCM)

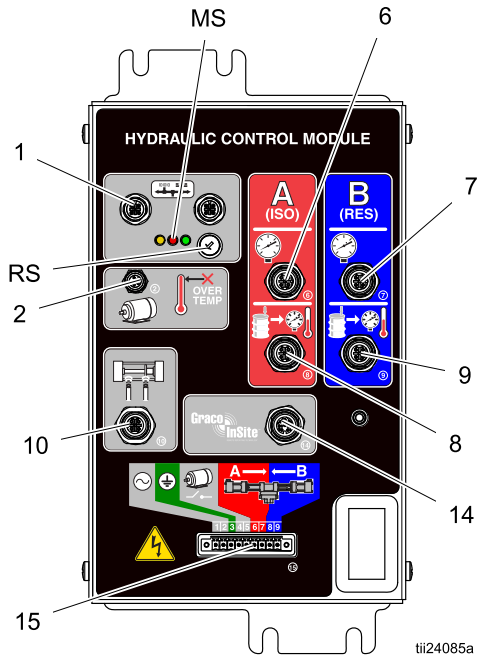

Figure 7

	Description
MS	Module Status LEDs see LED Status Table
1	CAN Communication Connections
2	Motor Over-Temperature
6	A Pump Output Pressure
7	B Pump Output Pressure
8	A Fluid Inlet Sensor
9	B Fluid Inlet Sensor
10	Pump Position Switches
14	Graco Insite™
15	Motor Contactor and Solenoids
RS	Rotary Switch

HCM Rotary Switch (RS) Positions

- 0 = Reactor 2, H-30
- 1 = Reactor 2, H-40
- 2 = Reactor 2, H-50
- 3 = Reactor 2, H-XP2
- 4 = Reactor 2, H-XP3

Table 3 HCM Module LED (MS) Status Descriptions

LED	Conditions	Description
HCM Status	Green Solid	Power applied to module
	Yellow Solid	Active Communication
	Red Steady Flashing	Software upload from token in progress
	Red Random Flashing or Solid	Module error exists

Temperature Control Module (TCM) Cable Connections

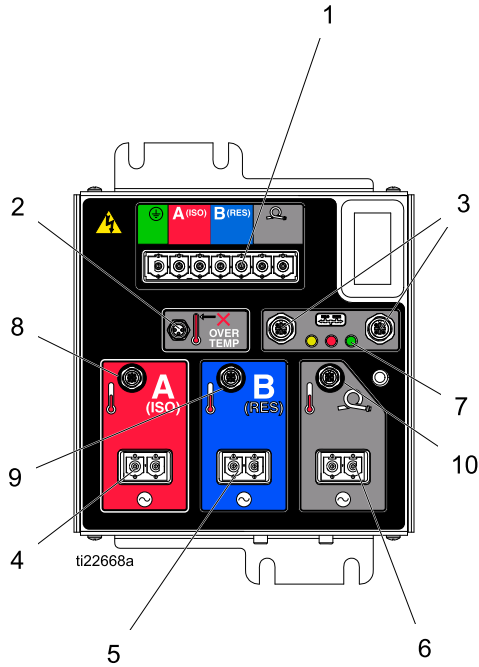

Figure 8

- 1 Power Input
- 2 Heater Over-temperature
- 3 CAN Communications Connections
- 4 Power Out Heater A (ISO)
- 5 Power Out Heater B (Res)
- 6 Power Out (Heated Hose)
- 7 Module Status LEDs
- 8 Heater A (ISO) Temperature
- 9 Heater B (RES) Temperature
- 10 Hose Temperature

Table 4 TCM Module LED (7) Status Descriptions

LED	Conditions	Description
TCM Status	Green Solid	Power applied to module
	Yellow Solid	Active Communication
	Red Steady Flashing	Software upload from token in progress
	Red Random Flashing or Solid	Module error exists

Installation

Mounting the System

To prevent serious injury due to system tipping over, make sure the Reactor is secured to the floor.				

NOTE: Wall mounting brackets are not included with the system. Evaluate the installation to determine if additional support is required beyond the floor mounting screws.

1. See [Dimensions, page 74](#) for mounting hole specifications.
2. Use a minimum of 4 of the 6 mounting holes, evenly spaced in the base of the system frame, to secure base to the floor.

NOTE: Bolts are not included.

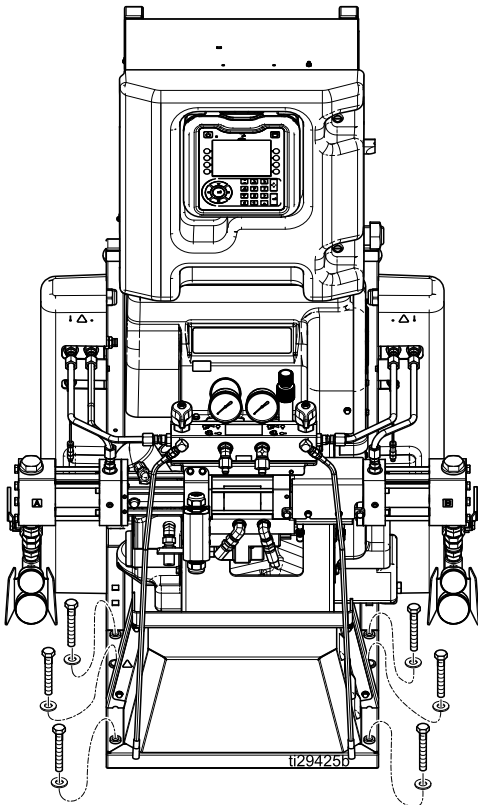

Setup

Grounding

The equipment must be grounded to reduce the risk of static sparking and electric shock. Electric or static sparking can cause fumes to ignite or explode. Improper grounding can cause electric shock. Grounding provides an escape wire for the electric current.				

- *Reactor:* System is grounded through the power cord.
- *Spray gun:* connect whip hose ground wire to FTS. See [Install Fluid Temperature Sensor, page 33](#). Do not disconnect ground wire or spray without whip hose.
- *Fluid supply containers:* follow your local code.
- *Object being sprayed:* follow your local code.
- *Solvent pails used when flushing:* follow your local code. Use only metal pails, which are conductive, placed on a grounded surface. Do not place pail on a nonconductive surface, such as paper or cardboard, which interrupts grounding continuity.
- *To maintain grounding continuity when flushing or relieving pressure,* hold a metal part of spray gun firmly to the side of a grounded *metal* pail, then trigger gun.

General Equipment Guidelines

NOTICE

Failure to properly size the equipment may result in damage. To avoid damage to the equipment, follow the guidelines listed below.

- Determine the correct size generator. Using the correct size generator and proper air compressor will enable the proportioner to run at a nearly constant RPM. Failure to do so will cause voltage fluctuations that can damage electrical equipment. Ensure that the generator matches the voltage and phase of the proportioner.

Use the following procedure to determine the correct size generator.

1. List peak wattage requirements of all system components.
 2. Add the wattage required by the system components.
 3. Perform the following equation:
Total watts x 1.25 = kVA (kilovolt-amperes)
 4. Select a generator size that is equal to or greater than the determined kVA.
- Use proportioner power cords that meet or exceed the requirements listed in Table 5. Failure to do so will cause voltage fluctuations that can damage electrical equipment, and may cause the power cable to overheat.
 - Use an air compressor with continuous run head unloading devices. Direct online air compressors that start and stop during a job will cause voltage fluctuations that can damage electrical equipment.
 - Maintain and inspect the generator, air compressor, and other equipment per the manufacturer recommendations to avoid an unexpected shutdown. Unexpected equipment shutdown will cause voltage fluctuations that can damage electrical equipment.
 - Use a wall power supply with enough current to meet system requirements. Failure to do so will cause voltage fluctuations that can damage electrical equipment.

Connect Power

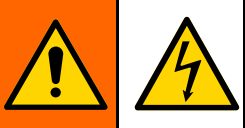

All electrical wiring must be done by a qualified electrician and comply with all local codes and regulations.

1. Turn main power switch (MP) OFF.
2. Open electrical enclosure door.

NOTE: Terminal jumpers are located inside the electrical enclosure door if equipped.
3. Install supplied terminal jumpers in the positions shown in image for the power source used (H-30 and H-XP2 models only).
4. Route power cable through strain relief (EC) in electrical enclosure.
5. Connect incoming power wires as shown in image. Gently pull on all connections to verify they are properly secured.
6. Verify all items are connected properly as shown in image then close electrical enclosure door.

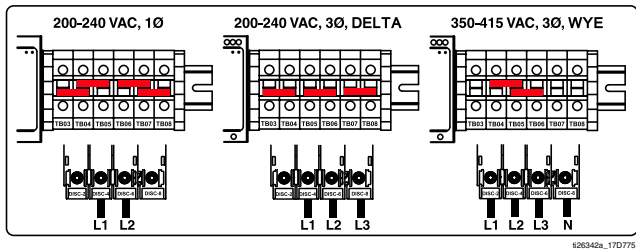

Table 5 Power Cord Requirements

Model	Input Power	Cord Specifications* AWG (mm ²)
H-30, 10.2 kW	200-240 VAC, 1 Phase	4 (21.2), 2 wire + ground
	200-240 VAC, 3 Phase, DELTA	8 (8.4), 3 wire + ground
	350-415 VAC, 3 Phase, WYE	8 (8.4), 4 wire + ground
H-30, 15.3 kW	200-240 VAC, 1 Phase	4 (21.2), 2 wire + ground
	200-240 VAC, 3 Phase, DELTA	6 (13.3), 3 wire + ground
	350-415 VAC, 3 Phase, WYE	8 (8.4), 4 wire + ground
H-XP2, 15.3 kW	200-240 VAC, 1 Phase	4 (21.2), 2 wire + ground
	200-240 VAC, 3 Phase, DELTA	6 (13.3), 3 wire + ground
	350-415 VAC, 3 Phase, WYE	8 (8.4), 4 wire + ground
H-40, 15.3 kW	200-240 VAC, 3 Phase, DELTA	6 (13.3), 3 wire + ground
	350-415 VAC, 3 Phase, WYE	8 (8.4), 4 wire + ground
H-40, 20.4 kW	200-240 VAC, 3 Phase, DELTA	4 (21.2), 3 wire + ground
	350-415 VAC, 3 Phase, WYE	6 (13.3), 4 wire + ground
H-50, 20.4 kW	200-240 VAC, 3 Phase, DELTA	4 (21.2), 3 wire + ground
	350-415 VAC, 3 Phase, WYE	6 (13.3), 4 wire + ground
H-XP3, 20.4 kW	200-240 VAC, 3 Phase, DELTA	4 (21.2), 3 wire + ground
	350-415 VAC, 3 Phase, WYE	6 (13.3), 4 wire + ground

*Values are for reference only. Refer to amperage listed in Models table (see [Models, page 9](#)) for given system and compare against latest version of local electrical code to select proper power cord size.

NOTE: 350–415 VAC systems are not designed to operate from 480 VAC power source.

Lubrication System Setup

Component A (ISO) Pump: Fill ISO lube reservoir (LR) with Graco Throat Seal Liquid (TSL), part 206995 (supplied).

1. Lift the lubricant reservoir (LR) out of the bracket (RB) and remove the container from the cap.

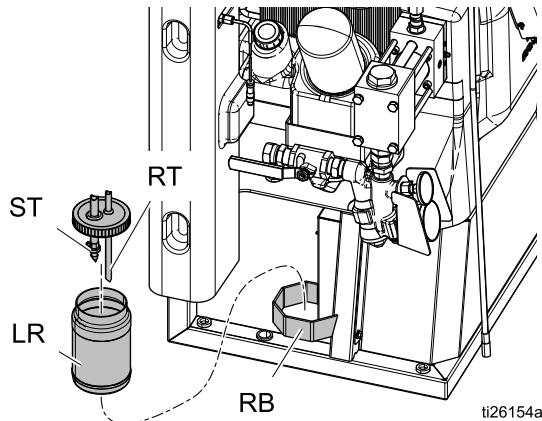

2. Fill with fresh lubricant. Thread the reservoir onto the cap assembly and place it in the bracket (RB).
3. Push the larger diameter supply tube (ST) approximately 1/3 of the way into the reservoir.
4. Push the smaller diameter return tube (RT) into the reservoir until it reaches the bottom.

NOTE: The return (RT) must reach the bottom of the reservoir to ensure that isocyanate crystals will settle to the bottom and not be siphoned into the supply tube (ST) and returned to the pump.

5. The lubrication is ready for operation. No priming is required.

Install Fluid Temperature Sensor

The Fluid Temperature Sensor (FTS) is supplied. Install FTS between main hose and whip hose (see your heated hose manual).

Connect Heated Hose to Proportioner

NOTICE

To avoid damage to the hose, only connect Reactor 2 proportioners to genuine Graco heated hoses.

Refer to your heated hose manual for detailed connection instructions.

1. Remove cover (CV).

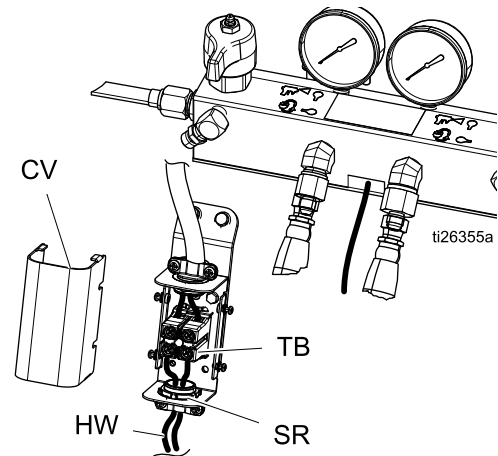

2. Route heated hose wires (HW) through strain relief (SR) and install wires into the open screw terminals on the terminal block (TB). Torque to 35 in-lb (3.95 N•m).
3. Reinstall cover (CV).

Advanced Display Module (ADM) Operation

When main power is turned on by turning the main power switch (MP) to the ON position, the power up screen will be displayed until communication and initialization is complete.



Then the power key icon screen will display until the ADM power on/off button  is pressed for the first time after system power-up.

To begin using the ADM, the machine must be active. To verify the machine is active, verify that the System Status Indicator Light is illuminated green, see [Advanced Display Module \(ADM\), page 22](#). If the System Status Indicator Light is not green, press the

ADM Power On/Off button . The System Status Indicator Light will illuminate yellow if the machine is disabled.



If Hose Resistance Mode is enabled, a reminder prompt will appear when the ADM becomes active.

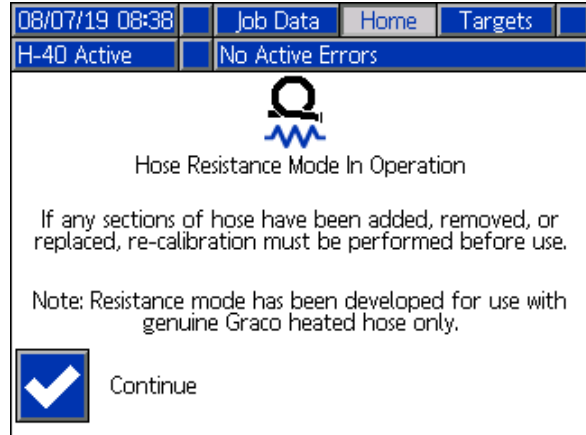







Press the Continue soft key  to clear the screen.

Perform the following tasks to fully setup your system.

1. Set pressure values for the Pressure Imbalance Alarm to activate. See [System Screen 1, page 38](#).
2. Enter, enable, or disable recipes. See [Recipes Screen, page 39](#).
3. Set general system settings. See [Advanced Screen 1 — General, page 37](#).
4. Set units of measure. See [Advanced Screen 2 — Units, page 37](#).
5. Set USB settings. See [Advanced Screen 3— USB, page 37](#).
6. Set target temperatures and pressure. See [Targets, page 42](#).
7. Set component A and component B supply levels. See [Maintenance, page 42](#).

Setup Mode

The ADM will start in the Run screens at the Home screen. From the Run screens, press  to access the Setup screens. The system defaults with no password, entered as 0000. Enter the current password then press . Press     to navigate through the Setup Mode screens (see [Navigating the Screens, page 24](#)).

Set Password

Set a password to allow Setup screen access, see [Advanced Screen 1 – General, page 37](#). Enter any number from 0001 to 9999. To remove the password, enter the current password in the Advanced Screen – General screen and change the password to 0000.

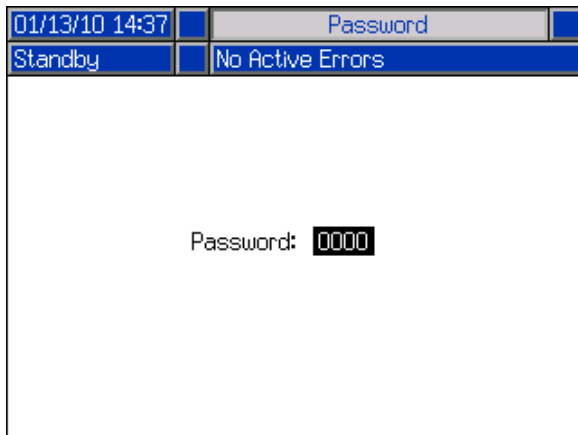

From the Setup screens, press  to return to the Run screens.

Advanced Display Module (ADM) Operation

Setup Screens Navigation

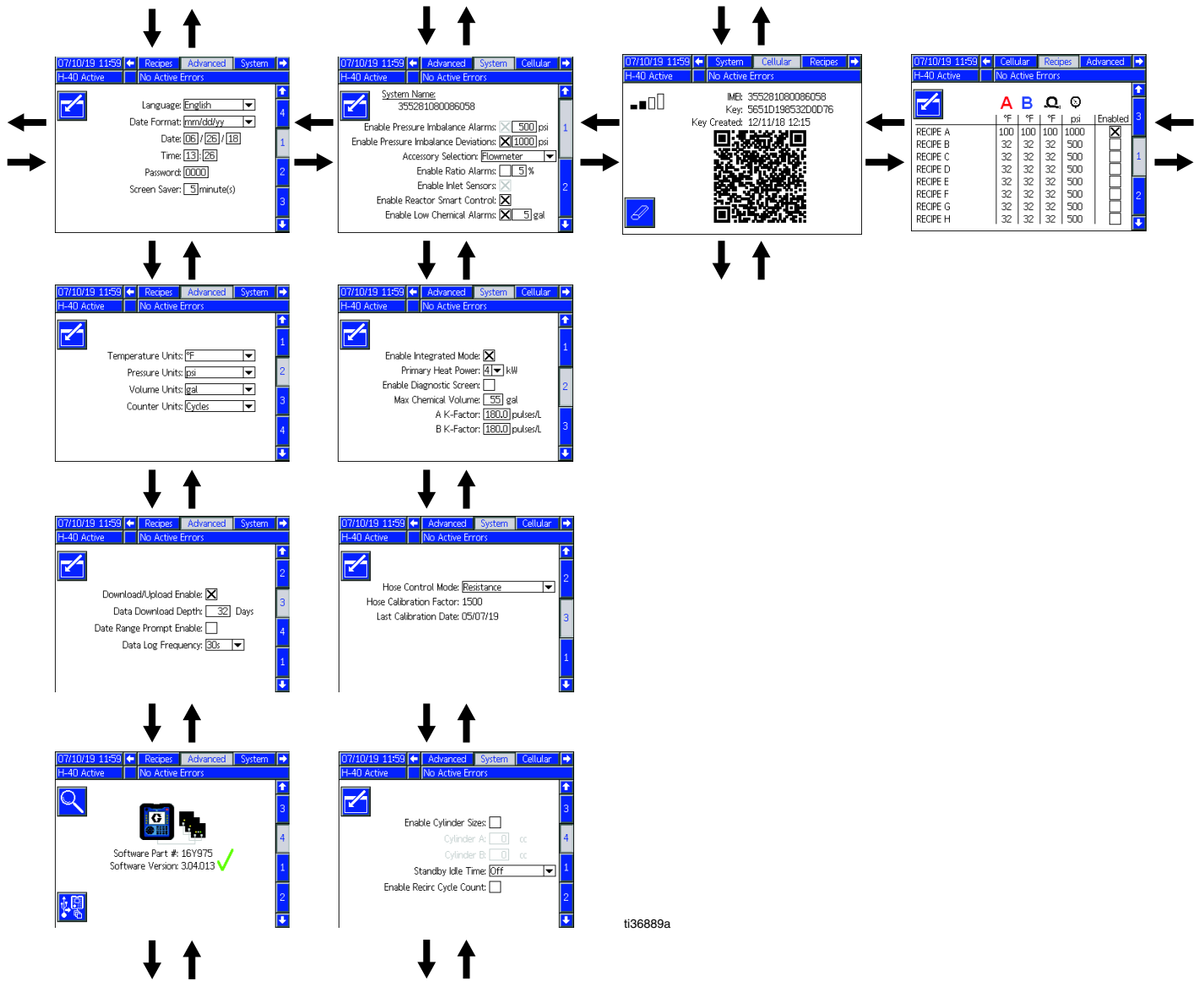

t136889a

Advanced Setup Screens

Advanced setup screens enable users to set units, adjust values, set formats, and view software information for each component. Press to scroll through the Advanced setup screens. Once in the desired Advanced setup screen, press to access the fields and make changes. When changes are complete press to exit edit mode.

NOTE: Users must be out of edit mode to scroll through the Advanced setup screens.

Advanced Screen 1 — General

Use this screen to set the language, date format, current date, time, setup screens password (0000 – for none) or (0001 to 9999), and screen saver delay (zero equals screen saver off).

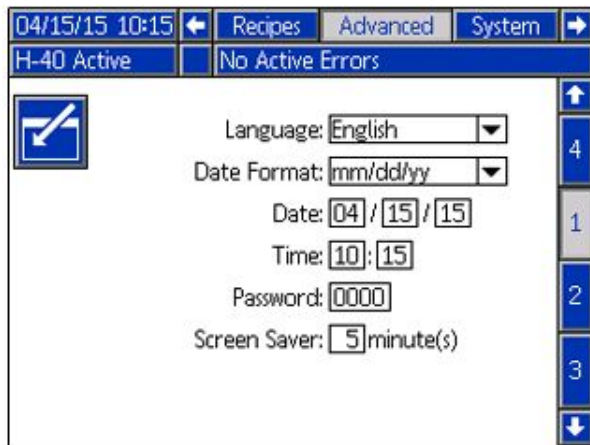

Advanced Screen 2 — Units

Use this screen to set the temperature units, pressure units, volume units, and cycle units (pump cycles or volume).

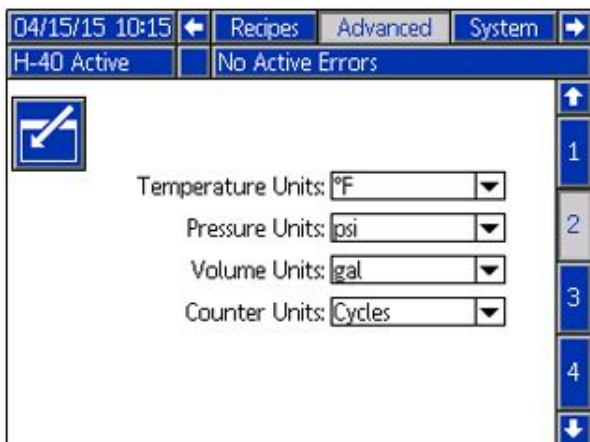

Advanced Screen 3 — USB

Use this screen to enable USB downloads/uploads, enable a logs 90% full advisory, enter the maximum number of days to download data, enable specifying date range of data to download, and how frequently USB logs are recorded. See [USB Data](#), page 69.

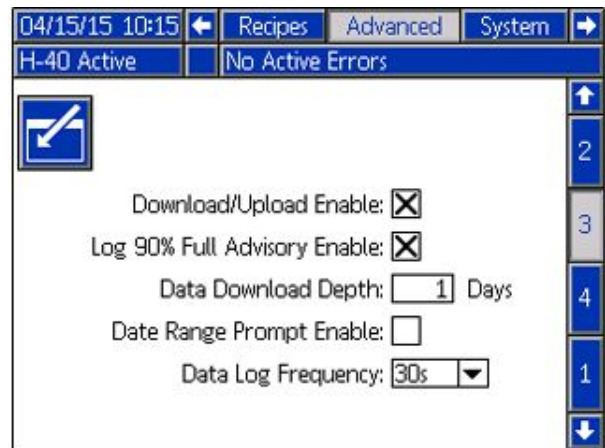

Advanced Screen 4 — Software

This screen displays the software part number. The software versions for the Advanced Display Module, Hydraulic Control Module, Temperature Control Module, USB Configuration, Load Center and Remote Display Module can be found by pressing

the search soft key .

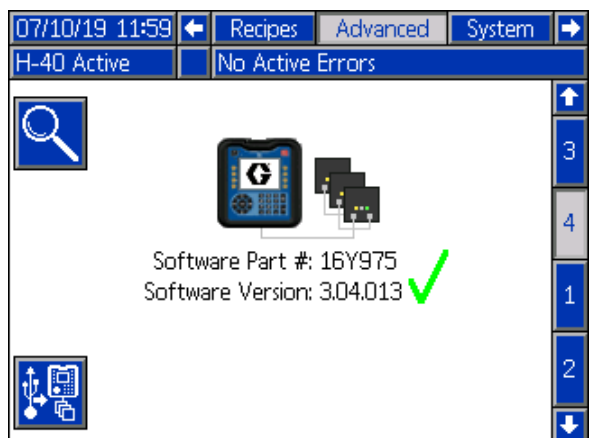

System 1

Use this screen to enable pressure imbalance alarms and deviations, set pressure imbalance values, enable inlet sensors, and enable low chemical alarms.

Select accessories using this screen. If the flow meter accessory is installed, use this screen to:

- Enable ratio errors
- Set the ratio alarm percentage

NOTE: Reactor Smart Control is not available for Reactor 2 Hydraulic systems.

12/11/18 12:13 | Advanced | System | Cellular

H-40 Active | No Active Errors

System Name: 355281080086058

Enable Pressure Imbalance Alarm: 500 psi

Enable Pressure Imbalance Deviation: 500 psi

Accessory Selection: Flowmeter

Enable Ratio Alarm: 5 %

Enable Inlet Sensors:

Enable Reactor Smart Control:

Enable Low Chemical Alarms: 5 gal

System 2

Use this screen to enable Integrated Mode and the diagnostic screen. This screen can also be used to set the primary heater size and the maximum drum volume.

Integrated Mode allows the Reactor 2 to control an Integrated PowerStation, if the Integrated PowerStation is installed. If the flow meter accessory is installed, use this screen to set the k-factors. K-factors are printed on the flow meter serial number labels.

07/10/19 11:59 | Advanced | System | Cellular

H-40 Active | No Active Errors

Enable Integrated Mode:

Primary Heat Power: 4 kW

Enable Diagnostic Screen:

Max Chemical Volume: 55 gal

A K-Factor: 180.0 pulses/L

B K-Factor: 180.0 pulses/L

System 3

Use this screen to select Hose Control Mode and perform calibration. See [Hose Control Modes, page 54](#) for information on the different hose control modes. Hose Resistance Mode can only be used if a calibration factor is stored. See [Calibration Procedure, page 57](#).

07/10/19 11:59 | Advanced | System | Cellular

H-40 Active | No Active Errors

Hose Control Mode: Resistance

Hose Calibration Factor: 1500

Last Calibration Date: 05/07/19

System 4

Use this screen to enable alternate pump cylinder sizes, to turn motor standby mode on and off, and to enable recirculation cycle count. Cycles below 700 psi (4.82 MPa, 48.2 Bar) outlet pressure will not be counted unless enabled.

07/10/19 11:59 | Advanced | System | Cellular

H-40 Active | No Active Errors

Enable Cylinder Sizes:

Cylinder A: 140 cc

Cylinder B: 140 cc

Standby Idle Time: 5 minutes

Enable Recirc Cycle Count:

Recipes

Use this screen to add recipes, view saved recipes, and enable or disable saved recipes. Enabled recipes can be selected at the Home Run Screen. 24 recipes can be displayed on the three recipe screens.

	°F	°F	°F	Enabled
RECIPE A	32	32	32	<input type="checkbox"/>
RECIPE B	32	32	32	<input type="checkbox"/>
RECIPE C	32	32	32	<input type="checkbox"/>
RECIPE D	32	32	32	<input type="checkbox"/>
RECIPE E	32	32	32	<input type="checkbox"/>
RECIPE F	32	32	32	<input type="checkbox"/>
RECIPE G	32	32	32	<input type="checkbox"/>
RECIPE H	32	32	32	<input type="checkbox"/>

Add Recipe

1. Press and then use to select a recipe field. Press to enter a recipe name (maximum 16 characters). Press to clear the old recipe name.

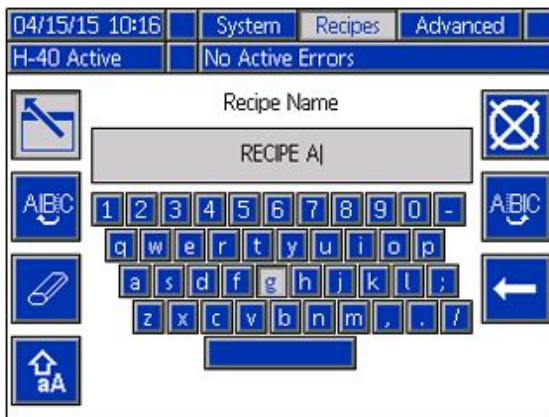

2. Use to highlight the next field and use the number pad to enter a value. Press to save.

Enable or Disable Recipes

1. Press and then use to select the recipe that needs to be enabled or disabled.
2. Use to highlight the enabled check box. Press to enable or disable the recipe.

Cellular Screen

Use this screen to connect the Reactor 2 App to the Reactor, to determine the cellular signal strength, or to reset the Reactor Key.



Reset Reactor Key

Resetting your Reactor Key prevents other users from remotely changing or viewing Reactor settings without first reconnecting to the Reactor.

1. On the Reactor ADM Cellular Screen, press to reset the Reactor key.
2. Press to confirm resetting the Reactor key.
3. Reconnect your app to the Reactor. See your Reactor 2 App installation manual.

NOTE: After resetting your Reactor key, all operators using the Graco Reactor 2 App must reconnect to the Reactor.

NOTE: For security of wireless control, change the Reactor key on a regular basis and whenever there is a concern about unauthorized access.

Run Mode

The ADM will start in the Run screens at the “Home” screen. Press to navigate through the Run Mode screens.

From the Run screens, press to access the Setup screens.

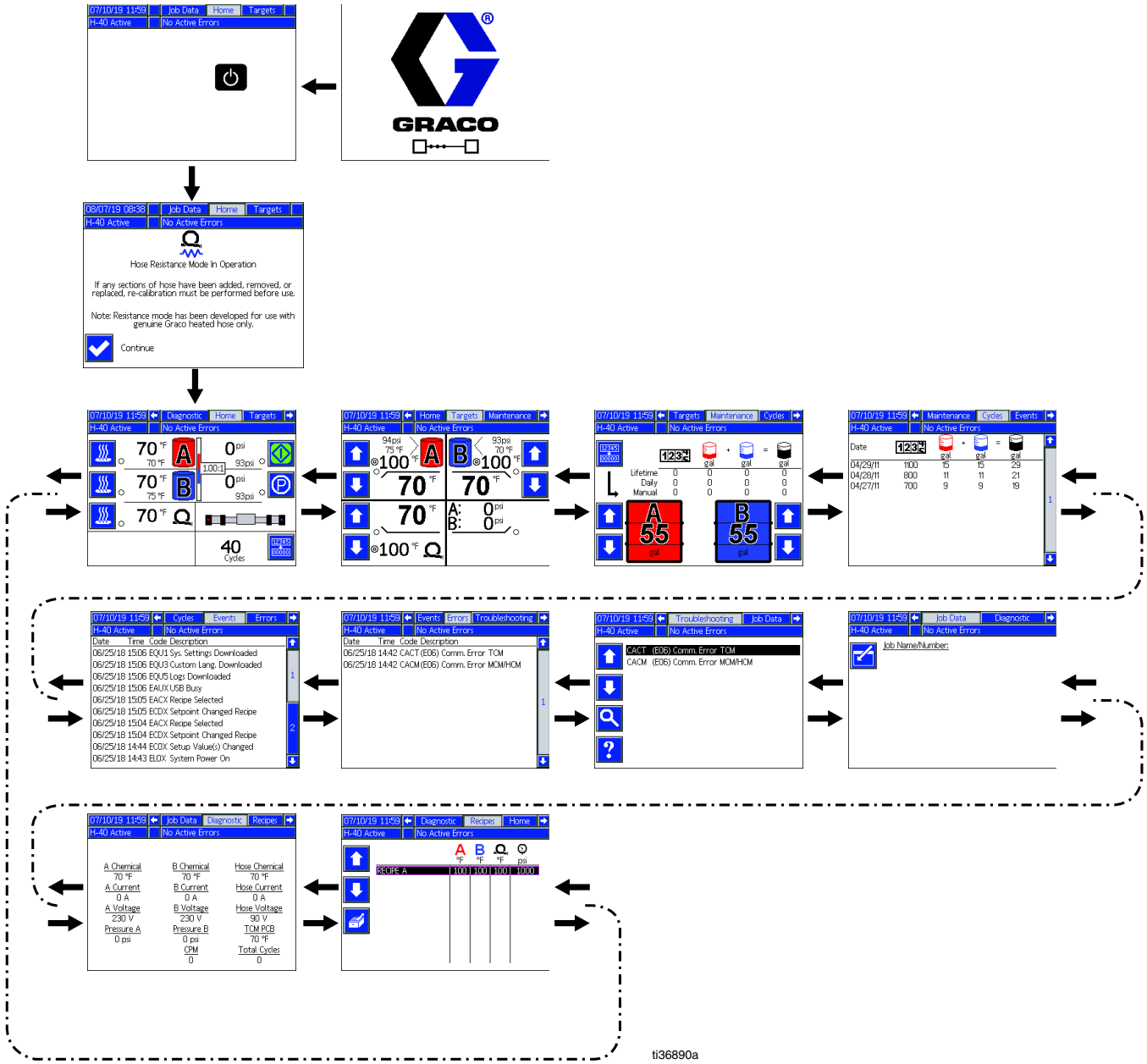

Run Screens Navigation Diagram
Figure 9

Home Screen - System Off

This is the home screen when the system is off. This screen displays actual temperatures, actual pressures at the fluid manifold, and number of cycles.

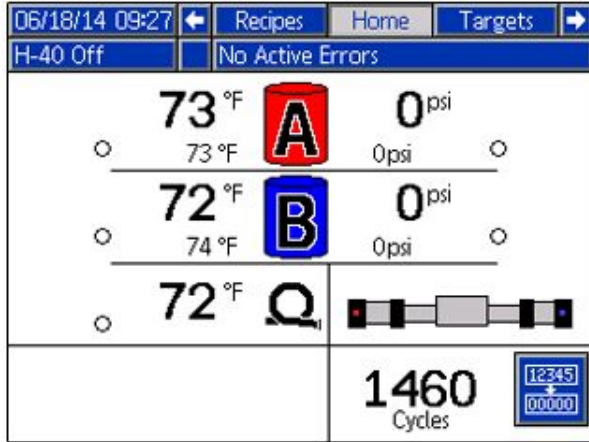

Home Screen - System Active

When the system is active, the home screen displays actual temperature for heat zones, actual pressures at the fluid manifold, coolant temperature, the number of cycles, along with all associated control soft keys.

Use this screen to turn on heat zones, view coolant temperature, start the proportioner, stop the proportioner, park the component A pump, and clear cycles.

NOTE: The screen shown displays inlet sensor temperatures and pressures. These will not be shown on models without inlet sensors.

NOTE: The screen shown displays flow bars and the flow ratio. The vertical bars indicate the level of flow through the meters. The numerical ratio indicates the ratio of A-side component to B-side component (ISO : RES). For example, if the ratio is 1.10 : 1, the proportioner is pumping more A-side component (ISO) than B-side component (RES). If the ratio is 0.90 : 1, the proportioner is pumping more B-side component (RES) than A-side component (ISO).

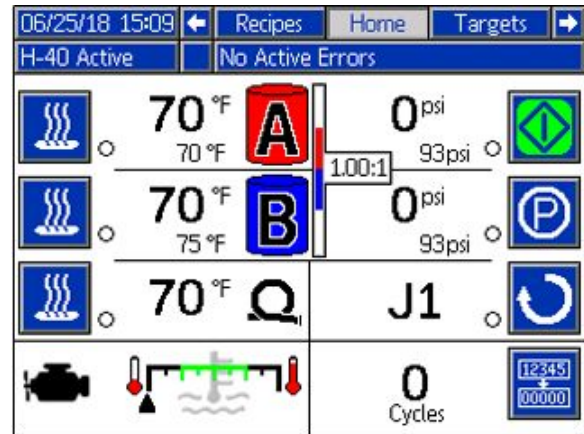

Home Screen - System With Error

Active errors are shown in the status bar. The error code, alarm bell, and description of the error will scroll in the status bar.

1. Press  to acknowledge the error.
2. See [Troubleshooting, page 68](#) for corrective action.

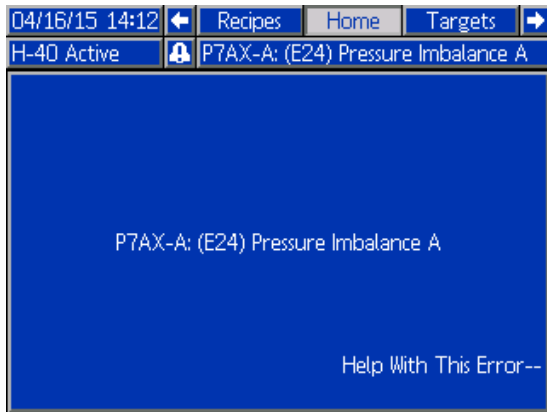

Targets Screen

Use this screen to define the set points for the A Component Temperature, B Component Temperature, heated hose temperature, and pressure.

Maximum A and B temperature: 190 °F (88 °C)

Maximum heated hose temperature: the lesser of 10 °F (5 °C) above the highest A or B temperature set point or 180 °F (82 °C).

NOTE: If the remote display module kit is used, these set points can be modified at the gun.

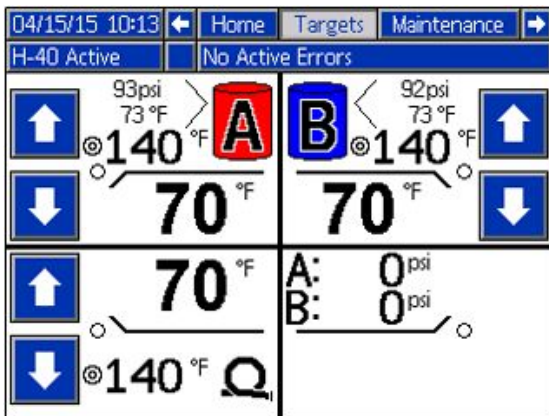

Maintenance Screen

Use this screen to view daily and lifetime cycles or gallons that have been pumped and gallons or liters remaining in the drums.

The lifetime value is the number of pump cycles or gallons since the first time the ADM was turned on.

The daily value automatically resets at midnight.

The manual value is the counter that can be manually reset. Press  and hold to reset manual counter.

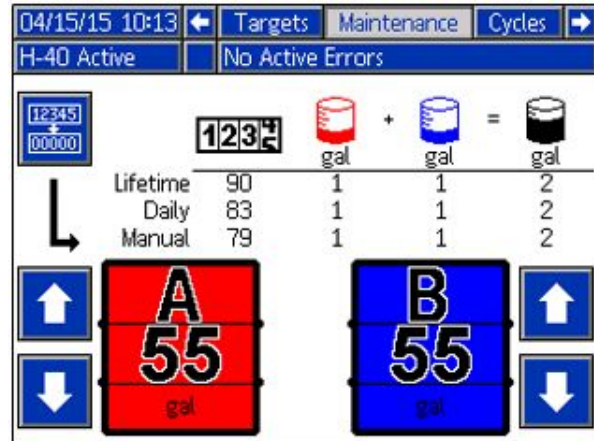

Cycles Screens

This screen shows daily cycles and gallons that have been sprayed for the day.

All information listed on this screen can be downloaded on a USB flash drive. To download logs, see [Download Procedure, page 69](#).

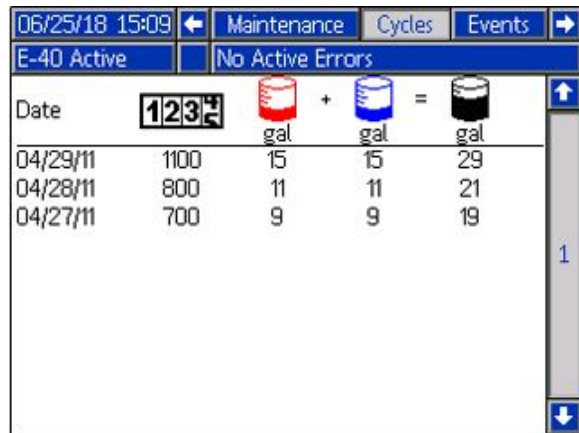

Events Screens

This screen shows the date, time, event code, and description of all events that have occurred on the system. There are 10 pages, each holding 10 events. The 100 most recent events are shown. See [System Events, page 46](#) for event code descriptions. See [Error Codes and Troubleshooting, page 68](#) for error code descriptions.

All events and errors listed on this screen can be downloaded on a USB flash drive. To download logs, see [Download Procedure, page 69](#).

04/15/15 10:14		Cycles	Events	Errors
H-40 Active		No Active Errors		
Date	Time	Code	Description	
04/15/15	10:13	ECDP	Setpoint Changed Pressure	4
04/15/15	10:13	ECDH	Setpoint Changed Hose	5
04/15/15	10:13	ECDB	Setpoint Changed B	1
04/15/15	10:13	ECDA	Setpoint Changed A	2
04/15/15	10:13	EBDA	Heat Off A	3
04/15/15	10:13	EBDB	Heat Off B	
04/15/15	10:13	EBDH	Heat Off Hose	
04/15/15	10:13	EADH	Heat On Hose	
04/15/15	10:13	EADB	Heat On B	
04/15/15	10:13	EADA	Heat On A	



Errors Screens

This screen shows the date, time, error code, and description of all errors that have occurred on the system.

All errors listed on this screen can be downloaded on a USB flash drive. To download logs, see [Download Procedure, page 69](#).

04/15/15 10:14		Events	Errors	Troubleshooting
H-40 Active		No Active Errors		
Date	Time	Code	Description	
04/15/15	08:11	H2MH	Low Frequency Hose	1
04/15/15	08:11	H2MB	Low Frequency B	
04/15/15	08:11	H2MA	Low Frequency A	2
04/15/15	08:11	V2MH	Low Voltage Hose	
04/15/15	08:11	V2MB	Low Voltage B	
04/15/15	08:11	V2MA	Low Voltage A	
04/15/15	08:11	T4NM(E27)	High Temp. Motor	
04/15/15	08:11	P6BX (E22)	Press. Sens. Err. B	
04/15/15	08:11	P6AX (E21)	Press. Sens. Err. A	
04/15/15	08:06	CACT (E06)	Comm. Error TCM	

Troubleshooting Screens

This screen displays the last ten errors that occurred on the system. Use the up and down arrows to select an error and press  to view the QR code for the selected error. Press  to access the QR code screen for an error code that is not listed on this screen. See [Error Codes and Troubleshooting, page 68](#), for more information on error codes.

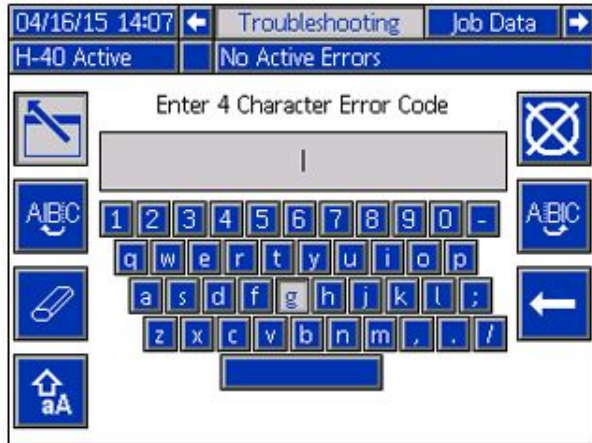
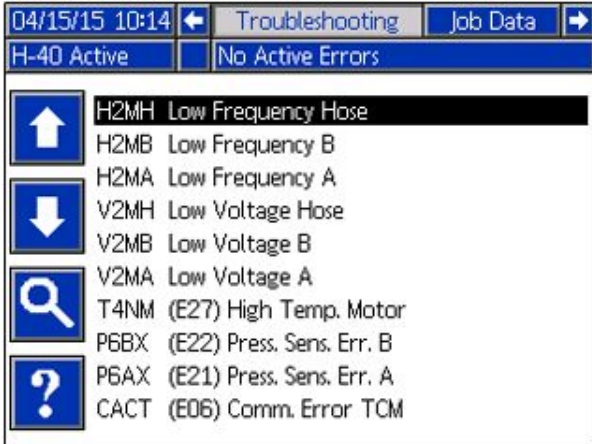

QR Codes



To quickly view online help for a given error code, scan the displayed QR code with your smartphone. Alternately, visit help.graco.com and search for the error code to view online help for that code.

Diagnostic Screen

Use this screen to view information for all system components. NOTE: If not visible, this screen may be on the Setup Systems screen (see [Setup Mode](#)).

04/16/15 13:58			Job Data	Diagnostic	Recipes
H-40 Active		No Active Errors			
A Chemical	B Chemical	Hose Chemical			
70 °F	70 °F	70 °F			
A Current	B Current	Hose Current			
0 A	0 A	0 A			
TCM PCB					
70 °F					
A Voltage	B Voltage	Hose Voltage			
230 V	230 V	90 V			
Pressure A	Pressure B				
501 psi	478 psi				
	CPM	Total Cycles			
	60	38			

The following information is displayed:

Temperature

- A Chemical
- B Chemical
- Hose Chemical
- TCM PCB — temperature control module temperature

Amps

- A Current (0–25 A for 10 kW heater, 0–38 A for 15 kW heater, 0–51 A for 20 kW heater)
- B Current (0–25 A for 10 kW heater, 0–38 A for 15 kW heater, 0–51 A for 20 kW heater)
- Hose Current (0–45 A typical)

Volts

- A Voltage — Voltage supplied to A heater (195–240 V typical)
- B Voltage — Voltage supplied to B heater (195–240 V typical)
- Hose Voltage (H-30 and H-XP2: 90 V; H-40, H-50, HXP3: 120 V)

Pressure

- Pressure A — chemical
- Pressure B — chemical

Cycles

- CPM — cycles per minute
- Total Cycles — lifetime cycles

NOTE: Maximum values based on maximum input voltage. Values will lower with lower voltage.

Job Data Screen

Use this screen to enter a job name or number.

04/15/15 10:14		Job Data	Home
H-40 Active		No Active Errors	
	Job Name/Number:		
	JOB 1		

Recipes Screen

Use this screen to select an enabled recipe. Use the up and down arrows to highlight a recipe and press



to load. The currently loaded recipe is outlined by a green box.

NOTE: This screen will not display if there are not any enabled recipes. To enable or disable recipes, see [Recipes](#), page 39.

06/21/11 10:43		Diagnostic	Recipes	Home
H-40 Active		No Active Errors		
		A °F	B °F	Q °F
				psi
	RECIPE A	180	180	180
	RECIPE B	120	120	120
	RECIPE C	100	100	100
	RECIPE D	100	100	100
	RECIPE E	100	100	100
	RECIPE F	100	100	100
	RECIPE G	100	100	100
	RECIPE H	100	100	100
	RECIPE I	110	110	110
	RECIPE J	125	125	125

System Events

Use the table below to find a description for all system non-error events. All events are logged in the USB log files.

Event Code	Description
EACX	Recipe Selected
EADA	Heat On A
EADB	Heat On B
EADH	Heat On Hose
EAPX	Pump On
EAUX	USB Drive Inserted
EB0X	ADM Red Stop Button Pressed
EBDA	Heat Off A
EBDB	Heat Off B
EBDH	Heat Off Hose
EBPX	Pump Off
EBUX	USB Drive Removed
EC0X	Setup Value Changed
ECDA	A Temperature Set Point Changed
ECDB	B Temperature Set Point Changed
ECDH	Hose Temperature Set Point Changed
ECDP	Pressure Set Point Changed
ECDX	Recipe Changed
EL0X	System Power On
EM0X	System Power Off
ENCH	Hose Calibration Updated
EP0X	Pump Parked
EQU1	System Settings Downloaded
EQU2	System Settings Uploaded
EQU3	Custom Language Downloaded
EQU4	Custom Language Uploaded
EQU5	Logs Downloaded
ER0X	User Counter Reset
EVSX	Standby
EVUX	USB Disabled

Startup

				
To prevent serious injury, only operate Reactor with all covers and shrouds in place.				

NOTICE

Proper system setup, startup, and shutdown procedures are critical to electrical equipment reliability. The following procedures ensure steady voltage. Failure to follow these procedures will cause voltage fluctuations that can damage electrical equipment and void the warranty.

1. Check fluid inlet filter screens.

Before daily startup, ensure that the fluid inlet screens are clean. See [Fluid Inlet Strainer Screens, page 64](#).

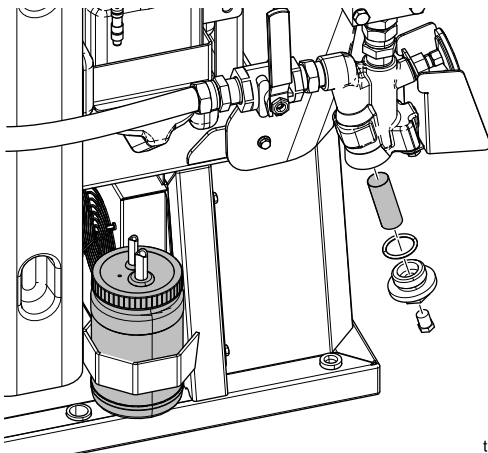

2. Check ISO lubrication reservoir.

Check level and condition of ISO lube daily. See [Pump Lubrication System, page 66](#).

3. Use A and B Drum Level Sticks (24M174) to measure the material level in each drum. If needed, the level can be entered and tracked in the ADM. See [Advanced Setup Screens, page 37](#).

4. Check generator fuel level.

NOTICE

Running out of fuel will cause voltage fluctuations that can damage electrical equipment and void the warranty. Do not run out of fuel.

5. Confirm main power switch is OFF before starting generator.

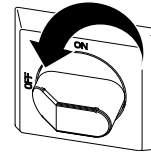

6. Ensure the main breaker on the generator is in the off position.
7. Start the generator. Allow it to reach full operating temperature.



8. Turn main power switch ON.

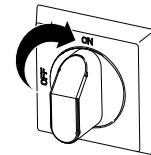

The ADM will display the following screen until communication and initialization is complete.



Startup

9. Switch on the air compressor, air dryer, and breathing air, if included.

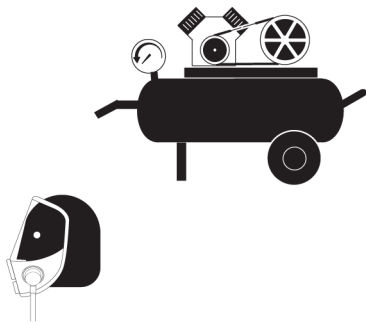

10. For first startup of new system, load fluid with feed pumps.

- Check that all **Setup** steps are complete. See [Setup Mode](#).
- If an agitator is used, open the agitator's air inlet valve.
- If you need to circulate fluid through the system to preheat the drum supply, see [Circulation Through Reactor, page 50](#). If you need to circulate material through the heat hose to the gun manifold, see [Circulation Through Gun Manifold, page 51](#).
- Turn both PRESSURE RELIEF/SPRAY valves (SA, SB) to SPRAY .

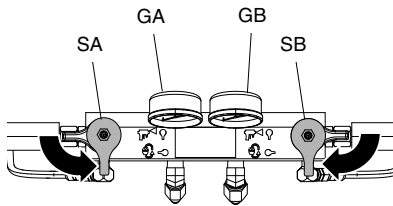

- e. Open fluid inlet valves (FV). Check for leaks.

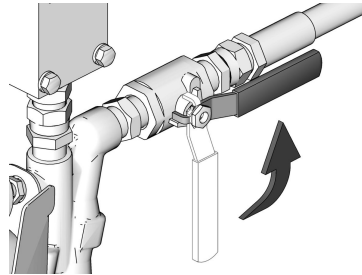

Cross-contamination can result in cured material in fluid lines which could cause serious injury or damage equipment. To prevent cross-contamination:

- **Never** interchange component A and component B wetted parts.
- Never use solvent on one side if it has been contaminated from the other side.
- Always provide two grounded waste containers to keep component A and component B fluids separate.

- f. Hold gun fluid manifold over two grounded waste containers. Open fluid valves A and B until clean, air-free fluid comes from valves. Close valves.

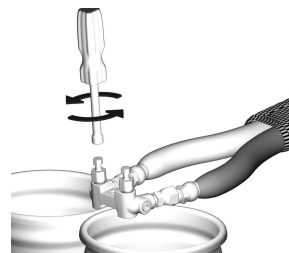

The Fusion AP gun manifold is shown.

11. Press  to activate ADM.

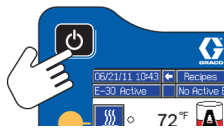

12. If necessary, setup the ADM in Setup Mode. See [Advanced Display Module \(ADM\) Operation, page 34.](#)

13. Preheat the system:

a. Press  to turn on hose heat zone.

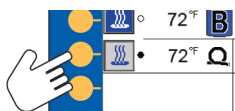

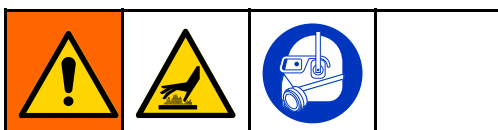

NOTE: In order to run without a fluid temperature sensor in Hose Resistance Mode, a calibration factor must be saved. See [Calibration Procedure, page 57.](#)



This equipment is used with heated fluid which can cause equipment surfaces to become very hot. To avoid severe burns:

- Do not touch hot fluid or equipment.
- Do not turn on hose heat without fluid in hoses.
- Allow equipment to cool completely before touching it.
- Wear gloves if fluid temperature exceeds 110 °F (43 °C).

			
<p>Thermal expansion can cause over-pressurization, resulting in equipment rupture and serious injury, including fluid injection. Do not pressurize system when preheating hose.</p>			

b. If you need to circulate fluid through the system to preheat the drum supply, see [Circulation Through Reactor, page 50.](#) If you need to circulate material through the heat hose to the gun manifold, see [Circulation Through Gun Manifold, page 51.](#)

c. Wait for the hose to reach set point temperature.



NOTE: Hose heat-up time may increase at voltages less than nominal 230 VAC when maximum hose length is used.

d. Press  to turn on A and B heat zones.

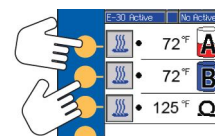

Fluid Circulation

Circulation Through Reactor

NOTICE

To prevent equipment damage, do not circulate fluid containing a blowing agent without consulting with your material supplier regarding fluid temperature limits.

NOTE: Optimum heat transfer is achieved at lower fluid flow rates with temperature set points at desired drum temperature. Low temperature rise deviation errors may result.
To circulate through gun manifold and preheat hose, see [Circulation Through Gun Manifold, page 51](#).

1. Follow [Startup, page 47](#).

<p>To avoid injection injury and splashing, do not install shutoffs downstream of the PRESSURE RELIEF/SPRAY valve outlets (BA, BB). The valves function as overpressure relief valves when set to SPRAY . Lines must be open so valves can automatically relieve pressure when machine is operating.</p>			

2. See [Typical Installation, with system fluid manifold to drum circulation, page 18](#). Route circulation lines back to respective component A or B supply drum. Use hoses rated for the maximum working pressure of this equipment. See **Technical Specifications**.
3. Set PRESSURE RELIEF/SPRAY valves (SA, SB) to PRESSURE RELIEF/CIRCULATION

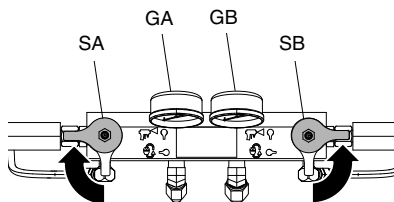

4. Set temperature targets. See [Targets Screen, page 42](#).
5. Before starting the motor, unlock the hydraulic compensator knob, then rotate counter-clockwise until it ceases to move.

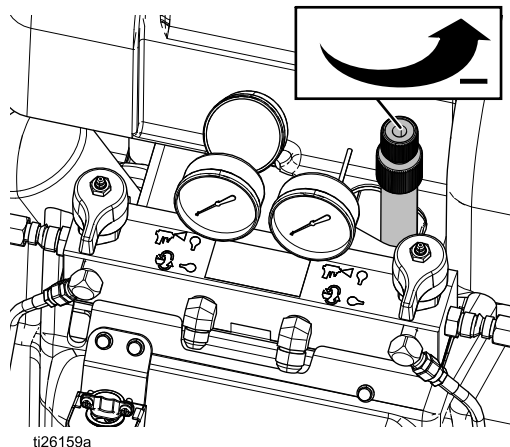

6. Press motor to start motor and pumps. Circulate fluid at lowest possible pressure until temperatures reach targets.
7. Press to turn on the hose heat zone.
8. Turn on the A and B heat zones. Wait until the fluid inlet valve temperature gauges (FTG) reach the minimum chemical temperature from the supply drums.
9. Turn off motor.
10. Set PRESSURE RELIEF/SPRAY valves (SA, SB) to SPRAY .

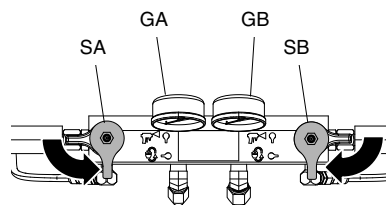

Circulation Through Gun Manifold

NOTICE

To prevent equipment damage, do not circulate fluid containing a blowing agent without consulting with your material supplier regarding fluid temperature limits.

NOTE: Optimum heat transfer is achieved at lower fluid flow rates with temperature set points at desired drum temperature. Low temperature rise deviation errors may result.

Circulating fluid through the gun manifold allows rapid preheating of the hose.

1. Install gun fluid manifold (P) on accessory circulation kit (CK). Connect high pressure circulation lines (R) to circulation manifold.

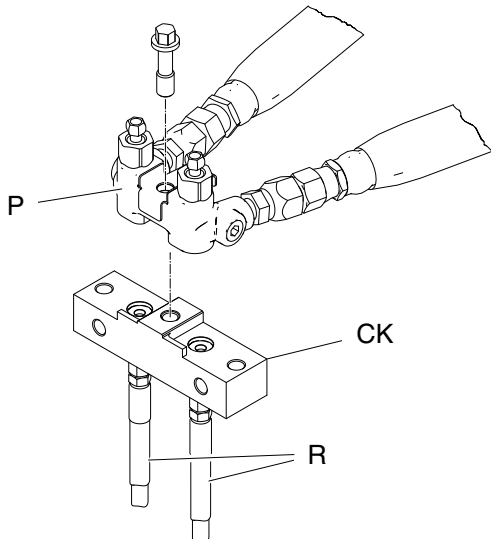

The Fusion AP gun manifold is shown.

CK	Gun	Manual
246362	Fusion AP	309818
256566	Fusion CS	313058

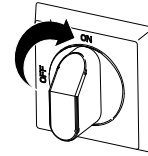

2. Route circulation lines back to respective component A or B supply drum. Use hoses rated for the maximum working pressure of this equipment. See [Technical Specifications, page 76](#).
3. Follow procedures from [Startup, page 47](#).
4. Turn main power switch on.

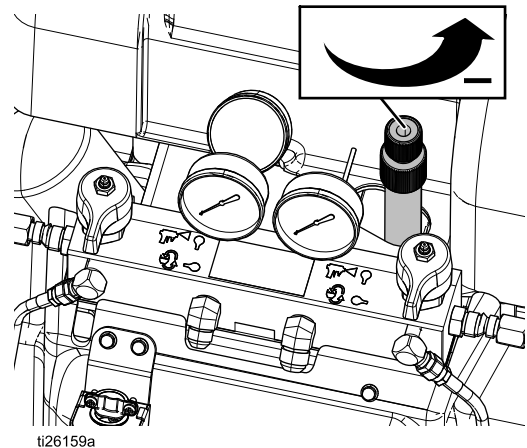

5. Set temperature targets. See [Targets Screen, page 42](#).
6. Before starting the motor, unlock the hydraulic compensator knob, then rotate counter-clockwise until it ceases to move.



ti26159a

7. Press motor  to start motor and pumps. Circulate fluid at lowest possible pressure until temperatures reach targets.
8. Press  to turn on the hose heat zone.
9. Turn on the A and B heat zones. Wait until the fluid inlet valve temperature gauges (FTG) reach the minimum chemical temperature from the supply drums.
10. Turn off motor.

Spraying

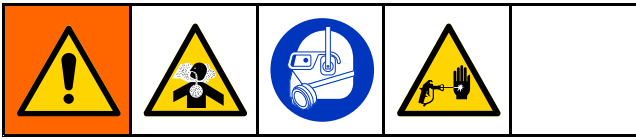

The Fusion AP gun is shown.

- Engage gun piston safety lock and close gun fluid inlet valves A and B.

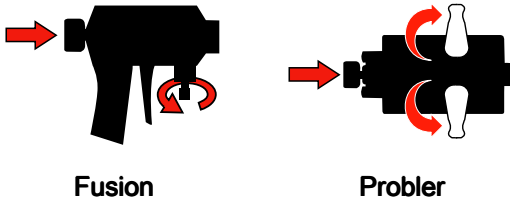

- Attach gun fluid manifold. Connect gun air line. Open air line valve.

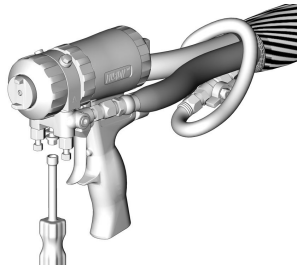

- Adjust the gun air pressure. Do not exceed 130 psi (0.2 MPa, 2 bar).
- Set PRESSURE RELIEF/SPRAY valves (SA, SB) to SPRAY.

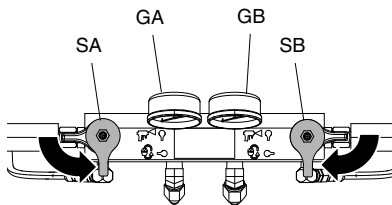

- Verify heat zones are on and temperatures are on target, see [Home Screen - System Off, page 41](#).

- Open fluid inlet valve (FV) located at each pump inlet.

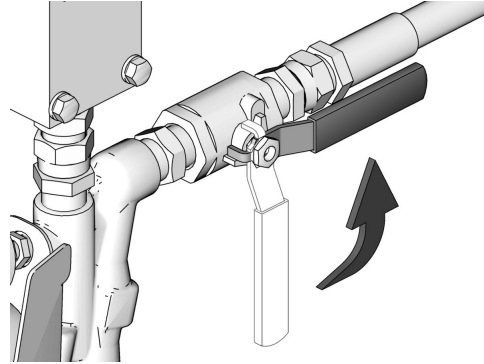

- Press  to start motor and pumps.



- Adjust pressure compensator knob to desired fluid stall pressure. Turn knob clockwise to increase pressure and counter-clockwise to decrease pressure. Use hydraulic pressure gauge (HPG) to view hydraulic pressure. Once desired fluid stall pressure is set, lock the knob in place by rotating lower portion clockwise until tight.

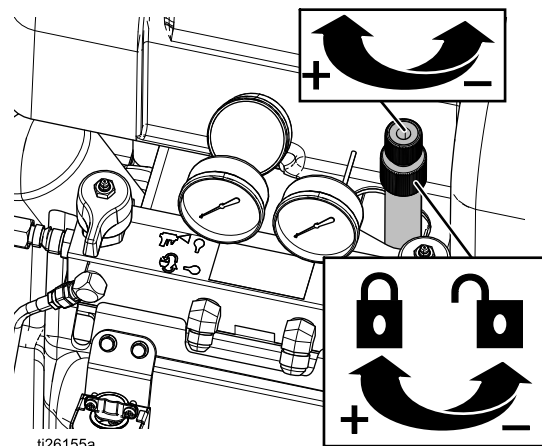

Component A and B outlet pressures will be higher than the hydraulic set pressure, depending on the model. Component A and B (GA, GB) pressure may be viewed on the pressure gauges or the ADM.

- Check fluid pressure gauges (GA, GB) to ensure proper pressure balance. If imbalanced, reduce pressure of higher component by **slightly** turning PRESSURE RELIEF/SPRAY valve for that component toward PRESSURE

RELIEF/CIRCULATION  until gauges show balanced pressures.

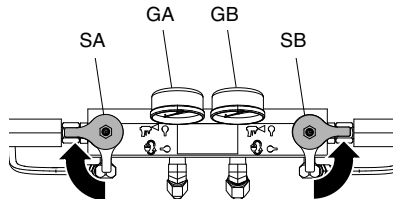

- Open gun fluid inlet valves A and B.

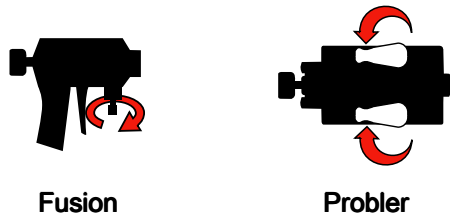

Fusion

Probler

NOTICE

To prevent material crossover on impingement guns, **never** open fluid manifold valves or trigger gun if pressures are imbalanced.

- Disengage gun piston safety lock.

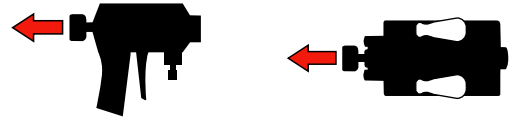

Fusion

Probler

- Pull gun trigger to test spray onto cardboard. If necessary, adjust pressure and temperature to get desired results.

Spray Adjustments

Flow rate, atomization, and amount of overspray are affected by four variables.

- Fluid pressure setting.** Too little pressure results in an uneven pattern, coarse droplet size, low flow, and poor mixing. Too much pressure results in excessive overspray, high flow rates, difficult control, and excessive wear.
- Fluid temperature.** Similar effects to fluid pressure setting. The A and B temperatures can be offset to help balance the fluid pressure.
- Mix chamber size.** Choice of mix chamber is based on desired flow rate and fluid viscosity.
- Clean-off air adjustment.** Too little clean-off air results in droplets building up on the front of the nozzle, and no pattern containment to control overspray. Too much clean-off air results in air-assisted atomization and excessive overspray.

Hose Control Modes

If the system produces the T6DH sensor error alarm or the T6DT sensor TCM alarm, use Hose Manual Mode until the hose RTD cable or FTS can be repaired, or use Hose Resistance Mode with a properly saved calibration factor.

Do not use Hose Manual Mode for extended periods of time. The system performs best when used in Hose FTS Mode or Hose Resistance Mode. Only use Hose Resistance Mode with genuine Graco heated hoses.

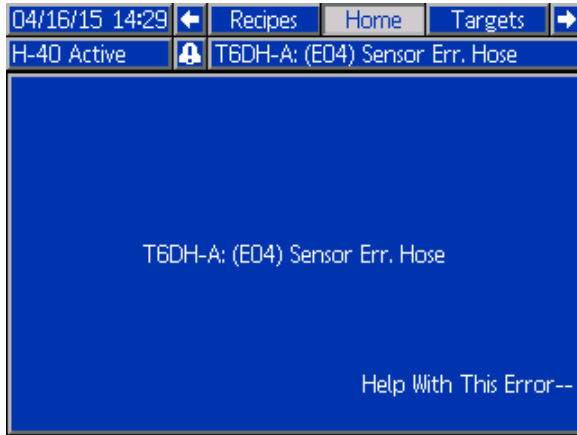

Hose Control Mode	Description
FTS	The fluid temperature sensor (FTS) installed in the hose automatically controls the hose fluid temperature. This mode requires the FTS to be installed and working properly.
Resistance	The hose heater element resistance automatically controls the hose fluid temperature. This mode will work with the FTS connected or disconnected. This mode requires a calibration factor (see Calibration Procedure, page 57).
Manual	The system supplies a set amount of hose current (amps) to heat the hose. The hose current is set by the user. This mode has no pre-programmed control and is designed to be used for a limited amount of time until the FTS issues are fixed, or a calibration factor is properly saved (see Calibration Procedure, page 57).

Enable Hose Resistance Mode

Hose Resistance Mode can be enabled to control hose heat without an FTS. This mode requires a calibration factor to run (see [Calibration Procedure, page 57](#)).

1. Enter Setup Mode and navigate to System screen 3.

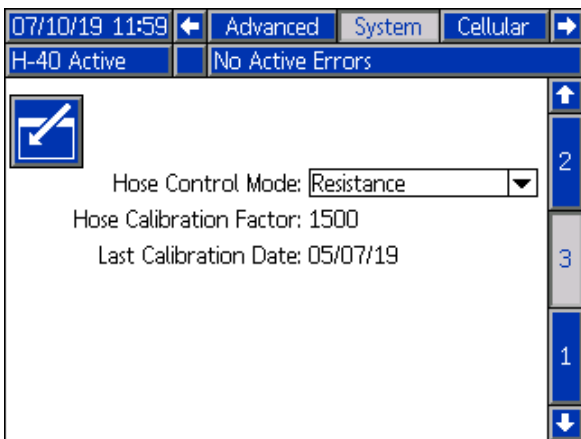

2. Select Resistance from the drop-down menu.

NOTE: If no calibration factor is shown, follow the [Calibration Procedure, page 57](#).

NOTICE

To prevent damage to the heated hose, a hose calibration is required if any of the following conditions are true:

- The hose has never been calibrated before.
- A section of hose has been replaced.
- A section of hose has been added.
- A section of hose has been removed.

3. Enter Run Mode and navigate to the Targets screen. Use the up and down arrows to set the desired temperature.

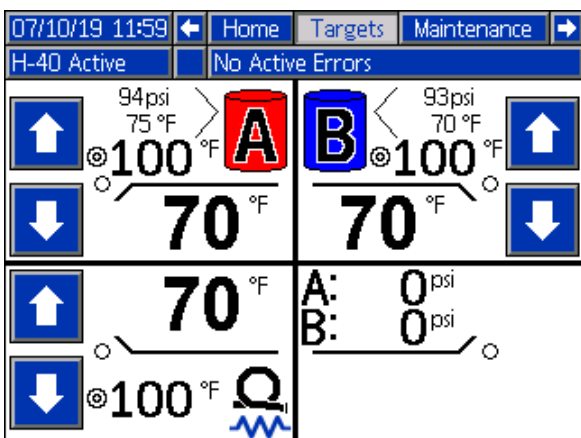

NOTE: Hose Resistance Mode controls the average fluid temperature of the A and B fluid. Set the hose temperature set point halfway between the A and B temperature set points and adjust as needed to achieve desired performance.

4. Navigate back to the Run Mode home screen. The Hose Resistance Mode icon will display.

NOTE: When Hose Resistance Mode is enabled and the hose heat is off, the hose temperature will display “- - -”. In Hose Resistance Mode, temperature values are only displayed when the heat is on.

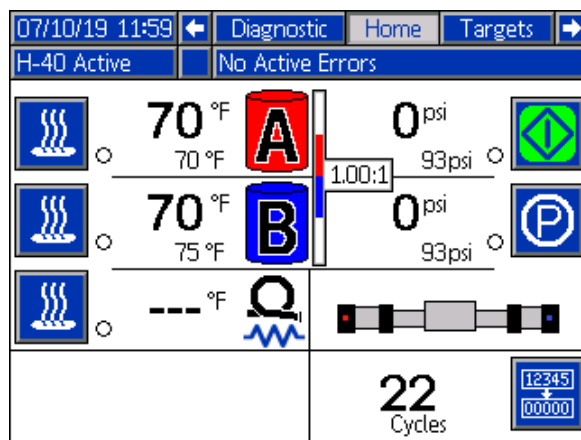

Disable Hose Resistance Mode

1. Enter Setup mode.
2. Navigate to System screen 3.
3. Set the Hose Control Mode to FTS.

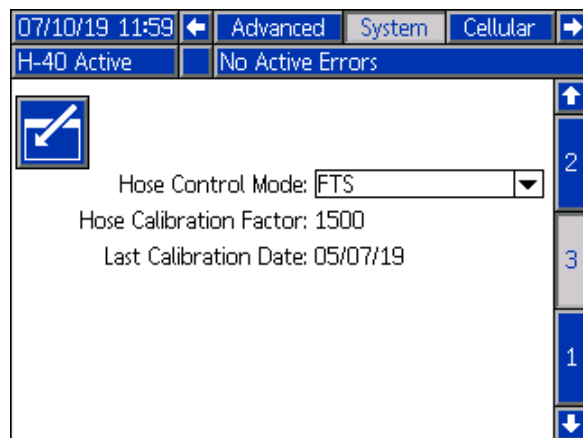

Enable Hose Manual Mode

1. Enter Setup Mode and navigate to System screen 3.

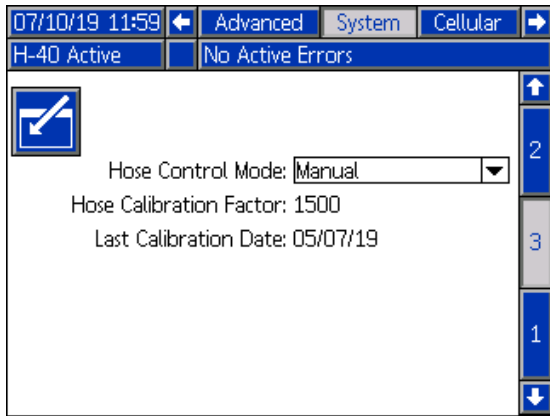

2. Select Manual from the Hose Control Mode drop-down menu.

NOTE: When Hose Manual Mode is enabled, the Hose Manual Mode advisory EVCH-V will appear.

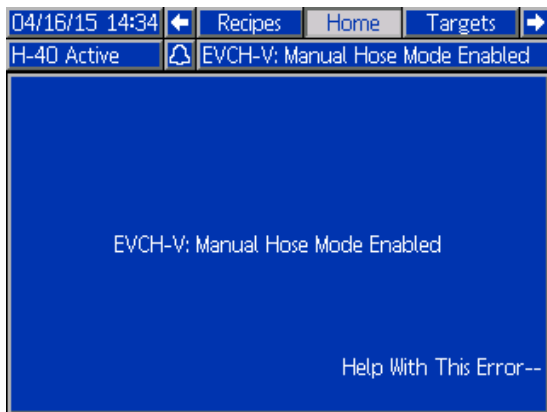

3. Enter Run Mode and navigate to the Targets screen. Use the up and down arrows to set the desired hose current.

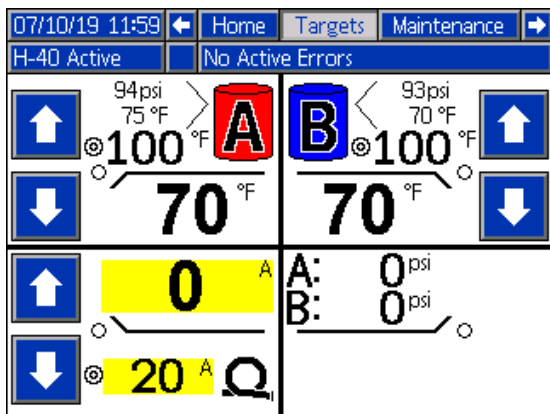

Hose Current Settings	Hose Current
Default	20A
Maximum	37A

4. Navigate back to the Run Mode Home screen. The hose will display a current instead of a temperature.

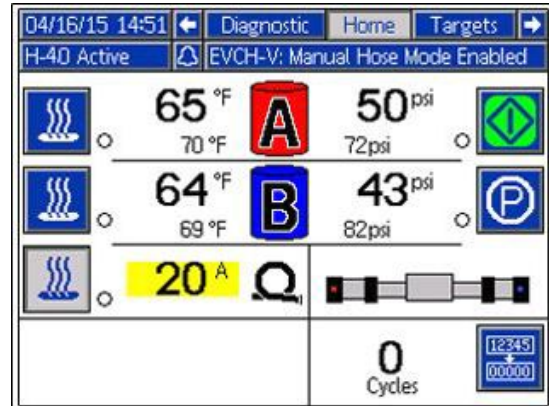

NOTE: Until the RTD sensor is repaired, the T6DH sensor error alarm will display each time the system is powered up.

Disable Hose Manual Mode

1. Enter Setup Mode.
2. Navigate to System screen 3.
3. Set the Hose Control Mode to FTS or Resistance.

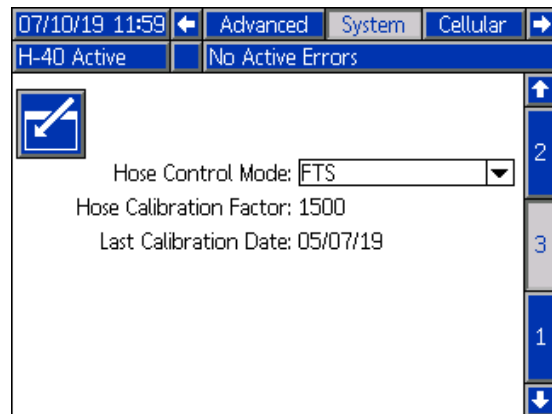



Calibration Procedure

NOTICE
<p>To prevent damage to the heated hose, a hose calibration is required if any of the following conditions are true:</p> <ul style="list-style-type: none"> • The hose has never been calibrated before. • A section of hose has been replaced. • A section of hose has been added. • A section of hose has been removed.



NOTE: The Reactor and heated hose must be at the same ambient temperature to get the most accurate calibration.

1. Enter Setup Mode and navigate to System



screen 3, then press the Calibrate soft key  .

07/10/19 11:59	Advanced	System	Cellular
H-40 Active	No Active Errors		
			
Hose Control Mode: FTS		▼	
Hose Calibration Factor: Manual		Resistance	
Last Calibration Date: 06/07/19			
 Calibrate			1

2. Press the Continue soft key  to acknowledge the reminder to have the hose at ambient conditions.

07/10/19 11:59	Advanced	System	Cellular
H-40 Active	No Active Errors		
<u>Hose Calibration</u>			
For best results, calibrate with hose at room temperature.			
 Continue			
 Cancel			

3. Wait while the system measures the hose resistance.

07/10/19 11:59	Advanced	System	Cellular
H-40 Active	No Active Errors		
<u>Hose Calibration</u>			
Measuring Hose Resistance...			
			
 Cancel			

NOTE: If hose heat was on prior to the calibration procedure, the system will wait up to five minutes to allow the wire temperature to equalize.

07/10/19 11:59	Advanced	System	Cellular
H-40 Active	No Active Errors		
<u>Hose Calibration</u>			
Waiting for hose wire temperature to equalize...			
0:52			
 Cancel			

NOTE: The hose temperature must be above 32 °F (0 °C) during calibration.

07/10/19 11:59	Advanced	System	Cellular
H-40 Active	No Active Errors		
<u>Hose Calibration</u>			
Unable to sense hose temperature! (< 32°F)			
 Cancel			

Spraying

- Accept or cancel the hose calibration.

NOTE: A temperature estimate will be displayed if the system was able to measure the hose wire resistance.

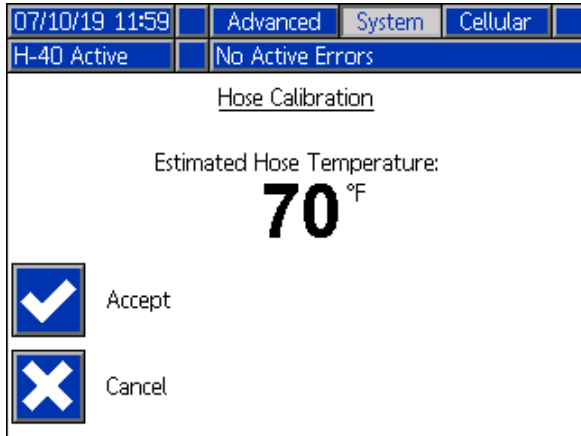

Standby



If you stop spraying for a period of time, the unit will enter standby by shutting down the electric motor and hydraulic pump, to reduce equipment wear and minimize heat buildup. The pump icon on the ADM Home screen will flash when in standby.

NOTE: The A, B, and Hose heat zones will not shut off during standby.





To restart, spray off target for two seconds. The system will sense the pressure drop and the motor will ramp up to full speed in a few seconds.

NOTE: This feature is disabled from the factory.

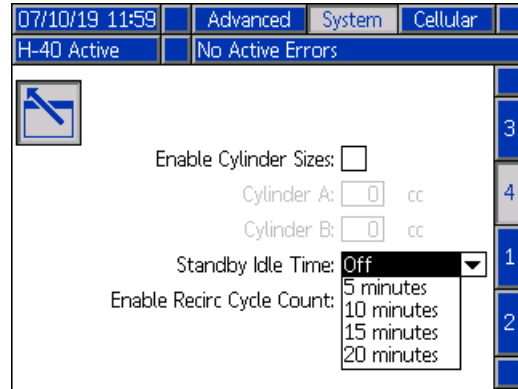
To activate or deactivate standby:

- Enter setup mode by pressing  on the ADM.
- Go to screen System 3 and select to  enter the page for editing.



- Select the "Standby Idle Time" drop-down using  and the arrow keys. Select the desired delay using  and the arrow keys. Press enter to select the desired value.
- Exit the page and return to run mode by pressing , then .

Shutdown

NOTICE

Proper system setup, startup, and shutdown procedures are critical to electrical equipment reliability. The following procedures ensure steady voltage. Failure to follow these procedures will cause voltage fluctuations that can damage electrical equipment and void the warranty.

1. Press  to stop the pumps.
2. Turn off all heat zones.



3. Relieve pressure. See [Pressure Relief Procedure, page 62](#).

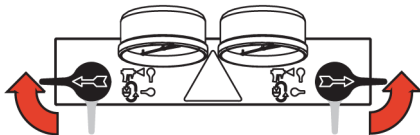

4. Press  to park the Component A and Component B pumps. The park operation is complete when green dot goes out. Verify the park operation is complete before moving to next step.

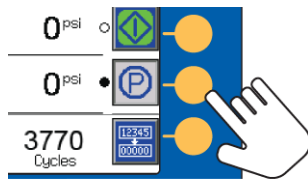

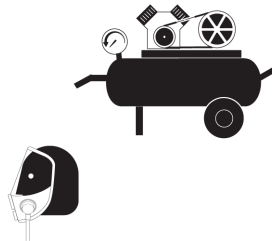

5. Press  to deactivate the system.

6. Turn off the air compressor, air dryer, and breathing air.

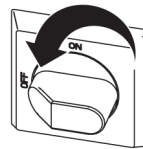

7. Turn main power switch OFF.



				
To prevent electric shock do not remove any covers or open the electrical enclosure door while the power is ON.				

8. Close all fluid supply valves.

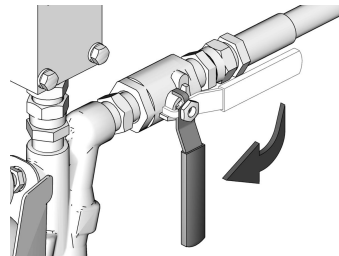

9. Set PRESSURE RELIEF/SPRAY valves to SPRAY to seal out moisture from the drain line.
10. Engage gun piston safety lock then close fluid inlet valves A and B.

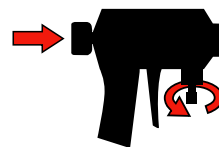

Fusion

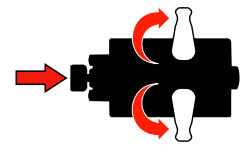

Probler

Purge Air Procedure

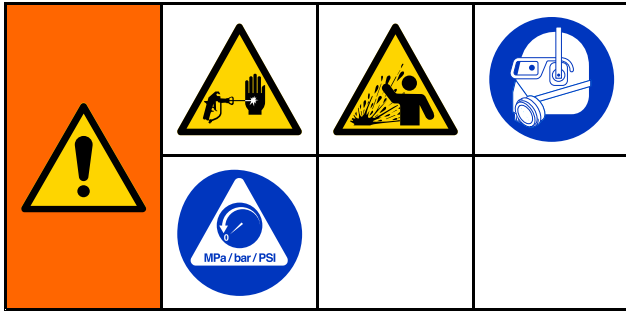

NOTE: Perform this procedure any time air is introduced into the system.

1. Relieve pressure. See [Pressure Relief Procedure, page 62](#).
2. Install a recirculation kit or install bleed lines between the outlet manifold recirculation fitting and a waste container.

NOTICE

To prevent equipment damage, do not circulate fluid containing a blowing agent without consulting with your material supplier regarding fluid temperature limits.

3. Press the proportioner stop button  to turn off the motor.
4. To relieve air pressure from the feed pumps, disconnect the air supply lines (G) from the feed pumps (K).

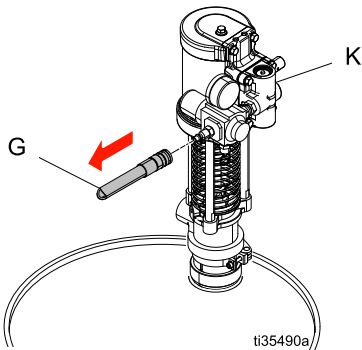

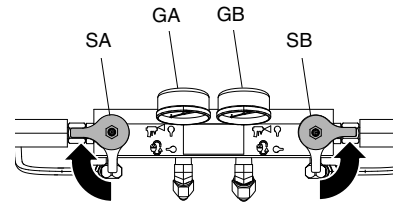

5. Set the PRESSURE RELIEF/SPRAY valves (SA, SB) to PRESSURE RELIEF/CIRCULATION .

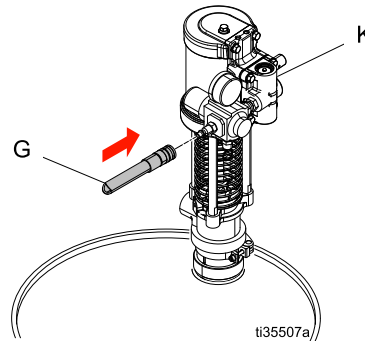

6. Adjust the pressure in the feed pump air supply lines to 100 psi.
7. To pressurize the feed pumps, connect the air supply lines (G) to the feed pumps (K).



8. Adjust the proportioner pressure compensator knob to less than 500 psi (3.4 MPa, 34 Bar).
9. Press the proportioner start button  to start the motor. Run 1 gallon (3.8 L) of material through the system.
10. Set the PRESSURE RELIEF/SPRAY valves (SA, SB) to SPRAY .

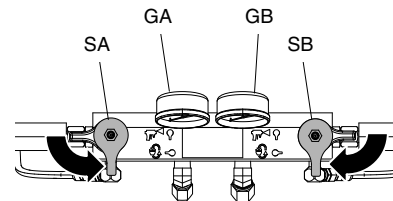

- To relieve air pressure from the feed pumps, disconnect the air supply lines (G) from the feed pumps (K).

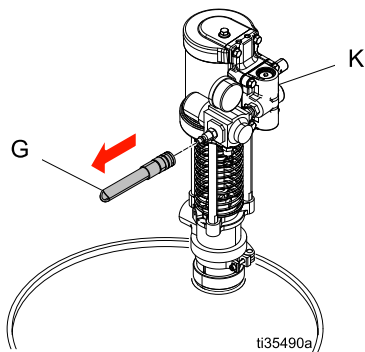

- Press the proportioner stop button  to exit Jog mode.

- Set the PRESSURE RELIEF/SPRAY valves (SA, SB) to PRESSURE RELIEF/CIRCULATION

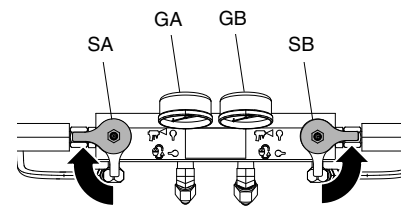

- Listen for a “spitting” sound from the bleed lines (N) or recirculation lines (R). See [Typical Installation, without circulation, page 17](#), [Typical Installation, with system fluid manifold to drum circulation, page 18](#), and [Typical Installation, with gun fluid manifold to drum circulation, page 19](#). This sound indicates that the Reactor 2 system still contains unwanted air. If the system still contains air, repeat the purge air procedure.

Pressure Relief Procedure



Follow the Pressure Relief Procedure whenever you see this symbol.

This equipment stays pressurized until pressure is manually relieved. To help prevent serious injury from pressurized fluid, such as skin injection, splashing fluid and moving parts, follow the Pressure Relief Procedure when you stop spraying and before cleaning, checking, or servicing equipment.

The Fusion AP gun is shown.

1. Press to stop the pumps.
2. Turn off all heat zones.

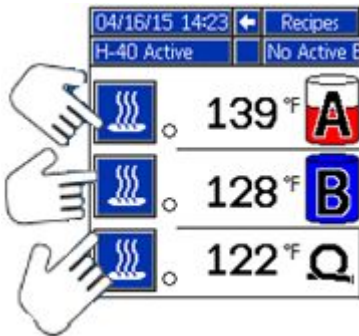

3. Relieve pressure in gun and perform gun shutdown procedure. See gun manual.

4. Close gun fluid inlet valves A and B.

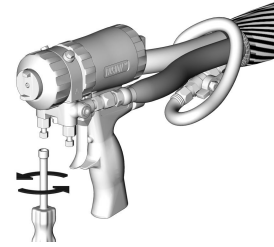

5. Shut off feed pumps and agitator, if used.
6. Route fluid to waste containers or supply tanks. Turn PRESSURE RELIEF/SPRAY valves (SA, SB) to PRESSURE RELIEF/CIRCULATION



7. Ensure gauges drop to 0.

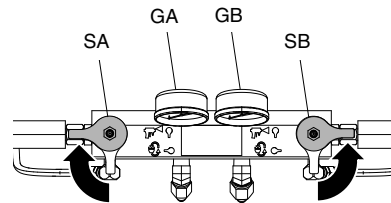



7. Engage gun piston safety lock.

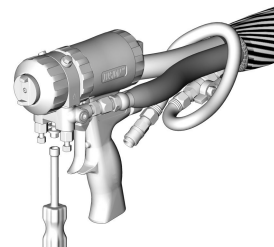

8. Disconnect gun air line and remove gun fluid manifold.



Flushing

				
<p>To avoid fire and explosion:</p> <ul style="list-style-type: none"> • Flush equipment only in a well-ventilated area. • Ensure main power is off and heater is cool before flushing. • Do not turn on heater until fluid lines are clear of solvent. 				

To flush entire system, circulate through gun fluid manifold (with manifold removed from gun).

To prevent moisture from reacting with isocyanate, always leave the system filled with a moisture-free plasticizer or oil. Do not use water. Never leave the system dry. See [Important Two-Component Material Information, page 7](#).

To flush feed hoses, pumps, and heaters separately from heated hoses, set PRESSURE RELIEF/SPRAY valves (SA, SB) to PRESSURE

RELIEF/CIRCULATION . Flush through bleed lines (N).

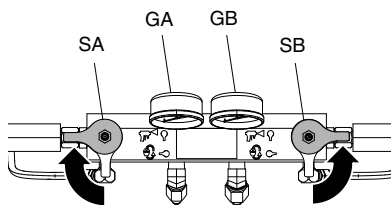

Maintenance

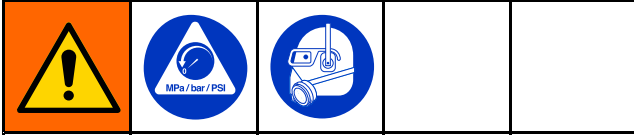

Prior to performing any maintenance procedures, follow [Pressure Relief Procedure, page 62](#).

Preventative Maintenance Schedule

The operating conditions of your particular system determine how often maintenance is required. Establish a preventive maintenance schedule by recording when and what kind of maintenance is needed, and then determine a regular schedule for checking your system.

- Inspect hydraulic and fluid lines for leaks daily.
- Clean up all hydraulic leaks; identify and repair the cause of the leak.
- Inspect fluid inlet strainer screens daily. See below.
- Keep component A from exposure to moisture to prevent crystallization.
- Check hydraulic fluid level weekly. Check hydraulic fluid level on a dipstick. Fluid level must be between indent marks on dipstick. Refill as required with approved hydraulic fluid, see **Technical Specifications** and the Approved Anti-Wear (AW) Hydraulic Oils table in the Reactor Repair-Parts manual 334946. If fluid is dark in color, change fluid and filter.

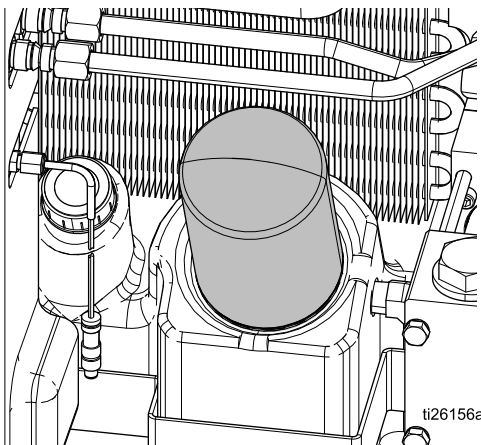

- Change break-in oil in a new unit after the first 250 hours of operation or within 3 months, whichever comes first. See the table below for recommended frequency of oil changes.

Table 6 Frequency of Oil Changes

Ambient Temperature	Recommended Frequency
0° to 90° F (-17° to 32° C)	1000 hours or 12 months, whichever comes first
90° F and above (32° C and above)	500 hours or 6 months, whichever comes first

Proportioner Maintenance

Fluid Inlet Strainer Screens

Inspect fluid inlet strainer screens daily, see [Fluid Inlet Strainer Screens, page 64](#).

Grease Circulation Valves

Grease circulation valves (SA and SB) with Fusion grease (117773) weekly.

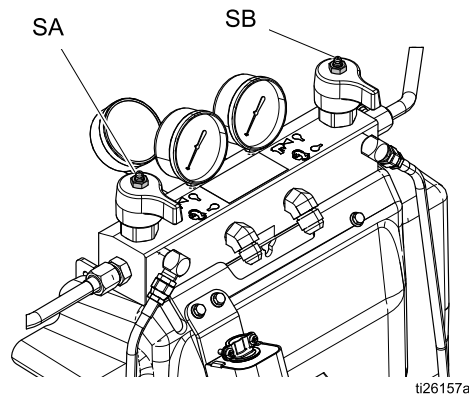

ISO Lubricant Level

Inspect ISO lubricant level and condition daily. Refill or replace as needed. See [Pump Lubrication System, page 66](#).

Moisture

To prevent crystallization, do not expose component A to moisture in air.

Gun Mix Chamber Ports

Clean gun mix chamber ports regularly. See gun manual.

Gun Check Valve Screens

Clean gun check valve screens regularly. See gun manual.

Dust Protection

Use clean, dry, oil-free compressed air to prevent dust buildup on control modules, fans, and motor (under shield).

Vent Holes

Keep vent holes on bottom and back of electrical enclosure and sides and back of transformer enclosure open..

Flush Inlet Strainer Screen

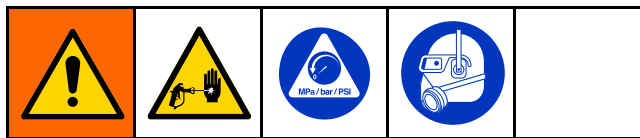

The inlet strainers filter out particles that can plug the pump inlet check valves. Inspect the screens daily as part of the startup routine, and clean as required.

Isocyanate can crystallize from moisture contamination or from freezing. If the chemicals used are clean and proper storage, transfer, and operating procedures are followed, there should be minimal contamination of the A-side screen.

NOTE: Clean the A-side screen only during daily startup. This minimizes moisture contamination by immediately flushing out any isocyanate residue at the start of dispensing operations.

1. Close the fluid inlet valve at the pump inlet and shut off the appropriate feed pump. This prevents material from being pumped while cleaning the screen.
2. Place a container under the strainer base to catch drain off when removing the strainer plug (C).
3. Remove the screen (A) from the strainer manifold. Thoroughly flush the screen with compatible solvent and shake it dry. Inspect the screen. No more than 25% of the mesh should be restricted. If more than 25% of the mesh is blocked, replace the screen. Inspect the gasket (B) and replace as required.
4. Ensure the pipe plug (D) is screwed into the strainer plug (C). Install the strainer plug with the screen (A) and o-ring (B) in place and tighten. Do not overtighten. Let the o-ring make the seal.
5. Open the fluid inlet valve, ensure that there are no leaks, and wipe the equipment clean. Proceed with operation.

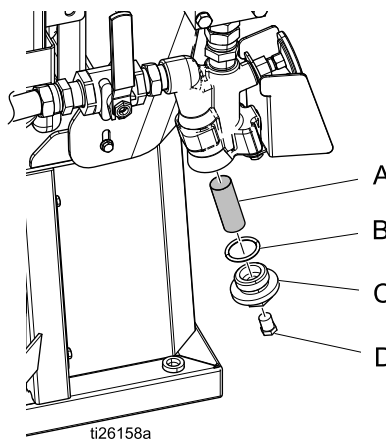

Figure 10

Pump Lubrication System

Check the condition of the ISO pump lubricant daily. Change the lubricant if it becomes a gel, its color darkens, or it becomes diluted with isocyanate.

Gel formation is due to moisture absorption by the pump lubricant. The interval between changes depends on the environment in which the equipment is operating. The pump lubrication system minimizes exposure to moisture, but some contamination is still possible.

Lubricant discoloration is due to continual seepage of small amounts of isocyanate past the pump packings during operation. If the packings are operating properly, lubricant replacement due to discoloration should not be necessary more often than every 3 or 4 weeks.

To change pump lubricant:

1. Follow [Pressure Relief Procedure](#), page 62.
2. Lift the lubricant reservoir (LR) out of the bracket (RB) and remove the container from the cap. Holding the cap over a suitable container, remove the check valve and allow the lubricant to drain. Reattach the check valve to the inlet hose.
3. Drain the reservoir and flush it with clean lubricant.
4. When the reservoir is flushed clean, fill with fresh lubricant.

5. Thread the reservoir onto the cap assembly and place it in the bracket.
6. Push the larger diameter supply (ST) tube approximately 1/3 of the way into the reservoir.
7. Push the smaller diameter return tube (RT) into the reservoir until it reaches the bottom.

NOTE: The return tube must reach the bottom of the reservoir to ensure that isocyanate crystals will settle to the bottom and not be siphoned into the supply tube and returned to the pump.

8. The lubrication system is ready for operation. No priming is required.

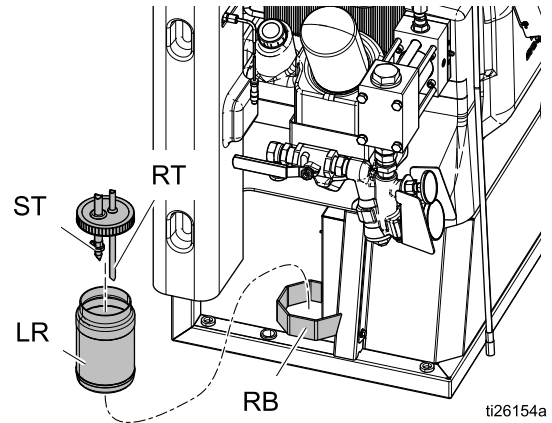

Pump Lubrication System
Figure 11

Errors

View Errors

When an error occurs the error information screen displays the active error code and description.

The error code, alarm bell, and active errors will scroll in the status bar. For a list of the ten most recent errors, see [Troubleshooting, page 68](#). Error codes are stored in the error log and displayed on the Error and Troubleshooting screens on the ADM.



There are three types of errors that can occur. Errors are indicated on the display as well as by the light tower (optional).

Alarms are indicated by . This condition indicates a parameter critical to the process has reached a level requiring the system to stop. The alarm needs to be addressed immediately.

Deviations are indicated by . This condition indicates a parameter critical to the process has reached a level requiring attention, but not sufficient enough to stop the system at this time.

Advisories are indicated by . This condition indicates a parameter that is not immediately critical to the process. The advisory needs attention to prevent more serious issues in the future.

To diagnose the active error, see [Troubleshoot Errors, page 67](#).

Troubleshoot Errors

To troubleshoot the error:

1. Press the soft key next to “Help With This Error” for help with the active error.

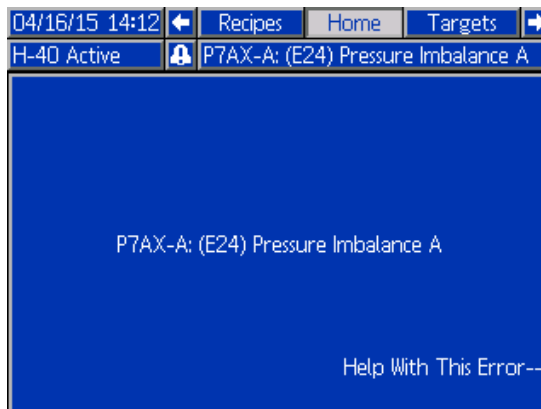







NOTE: Press or to return to the previously displayed screen.

2. The QR code screen will be displayed. Scan the QR code with your smartphone to be sent directly to online troubleshooting for the active error code. Otherwise, manually navigate to help.graco.com and search for the active error.



3. If no internet connection is available, see [Error Codes and Troubleshooting, page 68](#) for causes and solutions for each error code.

Troubleshooting

To avoid injury due to unexpected machine operation initiated by a remote controller, disconnect the Reactor 2 App cellular module, if equipped, from the system prior to troubleshooting. Refer to your Reactor 2 App manual for instructions.

See [Errors, page 67](#) for information about errors that can occur on the system.

See [Troubleshooting Screens, page 44](#) for the ten most recent errors that have occurred on the system. See [Troubleshoot Errors, page 67](#) to diagnose errors on the ADM that have occurred on the system.

Error Codes and Troubleshooting

See your system repair manual or visit help.graco.com for causes and solutions to each error code, or call your Graco contact listed on the back page of this manual.

USB Data

Download Procedure

NOTE: If log files are not correctly saving to the USB flash drive (for example, missing or empty log files), save desired data off of the USB flash drive and reformat it before repeating the download procedure.

NOTE: System configuration setting files and custom language files can be modified if the files are in the UPLOAD folder of the USB flash drive. See System Configuration Settings File, Custom Language File, and Upload Procedure sections.

1. Insert USB flash drive into USB port.
2. The menu bar and USB indicator lights indicate that the USB is downloading files. Wait for USB activity to complete.
3. Remove USB flash drive from USB port.
4. Insert USB flash drive into USB port of computer.
5. The USB flash drive window automatically opens. If it does not, open USB flash drive from within Windows® Explorer.
6. Open GRACO folder.
7. Open the system folder. If downloading data from more than one system, there will be more than one folder. Each folder is labeled with the corresponding serial number of the ADM (The serial number is on the back of the ADM.)
8. Open DOWNLOAD folder.
9. Open DATAxxxx folder labeled with the highest number. The highest number indicates the most recent data download.
10. Open log file. Log files open in Microsoft® Excel by default as long as the program is installed. However, they can also be opened in any text editor or Microsoft® Word.

NOTE: All USB logs are saved in Unicode (UTF-16) format. If opening the log file in Microsoft Word, select Unicode encoding.

USB Logs

NOTE: The ADM can read/write to FAT (File Allocation Table) storage devices. NTFS, used by 32 GB or greater storage devices, is not supported.

During operation, the ADM stores system and performance related information to memory in the form of log files. The ADM maintains six log files:

- Event Log
- Job Log
- Daily Log
- System Software Log
- Blackbox Log
- Diagnostics Log

Follow [Download Procedure, page 69](#), to retrieve log files.

Each time a USB flash drive is inserted into the ADM USB port, a new folder named DATAxxxx is created. The number at the end of the folder name increases each time a USB flash drive is inserted and data is downloaded or uploaded.

Event Log

The event log file name is 1-EVENT.CSV and is stored in the DATAxxxx folder.

The event log maintains a record of the last 49,000 events and errors. Each event record contains:

- Date of event code
- Time of event code
- Event code
- Event type
- Action taken
- Event Description

Event codes include both error codes (alarms, deviations, and advisories) and record only events.

Actions Taken includes setting and clearing event conditions by the system, and acknowledging error conditions by the user.

Job Log

The job log file name is 2–JOB.CSV and is stored in the DATAxxxx folder.

The job log maintains a record of data points based on the USB Log Frequency defined in the Setup screens. The ADM stores the last 237,000 data points for download. See [Advanced Setup Screens, page 37](#), for information on setting the Download Depth and USB Log Frequency.

- Data point date
- Data point time
- A side temperature
- B side temperature
- Hose temperature
- A side temperature set point
- B side temperature set point
- Hose temperature set point
- Pressure A
- Pressure B
- A side inlet pressure (Elite only)
- B side inlet pressure (Elite only)
- A side inlet temperature (Elite only)
- B side inlet temperature (Elite only)
- Inlet pressure set point
- System lifetime pump cycle counts
- Usage Volume (manual)
- Pressure, volume, and temperature units
- Job name/number

Daily Log

The daily log file name is 3–DAILY.CSV and is stored in the DATAxxxx folder.

The daily log maintains a record of the total cycle and volume sprayed on any day that the system is powered up. The volume units will be the same units that were used in the Job Log.

The following data is stored in this file:

- Date that material was sprayed
- Time — unused column
- Total pump cycle count for day
- Total volume sprayed for day

System Software Log

The system software file name is 4–SYSTEM.CSV and is stored in the DATAxxxx folder.

The system software log lists the following:

- Date log was created
- Time log was created
- Component name
- Software version loaded on the above component

Blackbox Log File

The black box file name is 5–BLACKB.CSV and is stored in the DATAxxxx folder.

The Blackbox log maintains a record of how the system runs and the features that are used. This log will help Graco troubleshoot system errors.

Diagnostics Log File

The diagnostics file name is 6–DIAGNO.CSV and is stored in the DATAxxxx folder.

The Diagnostics log maintains a record of how the system runs and the features that are used. This log will help Graco troubleshoot system errors.

System Configuration Settings

The system configuration settings file name is SETTINGS.TXT and is stored in the DOWNLOAD folder.

A system configuration settings file automatically downloads each time a USB flash drive is inserted into the ADM. Use this file to back up system settings for future recovery or to easily replicate settings across multiple systems. Refer to the [Upload Procedure, page 71](#) for instructions on how to use this file.

Custom Language File

The custom language file name is DISPTXT.TXT and is stored in the DOWNLOAD folder.

A custom language file automatically downloads each time a USB flash drive is inserted into the ADM. If desired, use this file to create a user-defined set of custom language strings to be displayed within the ADM.

The system is able to display the following Unicode characters. For characters outside of this set, the system will display the Unicode replacement character, which appears as a white question mark inside of a black diamond.

- U+0020 - U+007E (Basic Latin)
- U+00A1 - U+00FF (Latin-1 Supplement)
- U+0100 - U+017F (Latin Extended-A)
- U+0386 - U+03CE (Greek)
- U+0400 - U+045F (Cyrillic)

Create Custom Language Strings

The custom language file is a tab-delimited text file that contains two columns. The first column consists of a list of strings in the language selected at the time of download. The second column can be used to enter the custom language strings. If a custom language was previously installed, this column contains the custom strings. Otherwise the second column is blank.

Modify the second column of the custom language file as needed, and then follow the [Upload Procedure, page 71](#) to install the file.

The format of the custom language file is critical. The following rules must be followed in order for the installation process to succeed.

- Define a custom string for each row in the second column.

NOTE: If the custom language file is used, you must define a custom string for each entry in the DISPTXT.TXT file. Blank second-column fields will be displayed blank on the ADM.

- The file name must be DISPTXT.TXT.

- The file format must be a tab-delimited text file using Unicode (UTF-16) character representation.
- The file must contain only two columns, with columns separated by a single tab character.
- Do not add or remove rows from the file.
- Do not change the order of the rows.

Upload Procedure

Use this procedure to install a system configuration file and/or a custom language file.

1. If necessary, follow the **Download Procedure** to automatically generate the proper folder structure on the USB flash drive.
2. Insert USB flash drive into USB port of computer.
3. The USB flash drive window automatically opens. If it does not, open USB flash drive from within Windows Explorer.
4. Open GRACO folder.
5. Open the system folder. If working with more than one system, there will be more than one folder within the GRACO folder. Each folder is labeled with the corresponding serial number of the ADM. (The serial number is on the back of the ADM.)
6. If installing the system configuration settings file, place SETTINGS.TXT file into the UPLOAD folder.
7. If installing the custom language file, place DISPTXT.TXT file into the UPLOAD folder.
8. Remove USB flash drive from the computer.
9. Install USB flash drive into the ADM USB port.
10. The menu bar and USB indicator lights indicate that the USB is downloading files. Wait for USB activity to complete.
11. Remove USB flash drive from USB port.

NOTE: If the custom language file was installed, users can now select the new language from the Language drop-down menu in [Advanced Screen 1 — General, page 37](#).

Performance Charts

Use this chart to help identify the proportioner that will work most efficiently with each mix chamber. Flow rates are based on a material viscosity of 60 cps.

NOTICE

To prevent system damage, do not pressurize the system above the line for the gun tip size being used.

Foam Performance Chart

Table 7 Foam Performance Chart

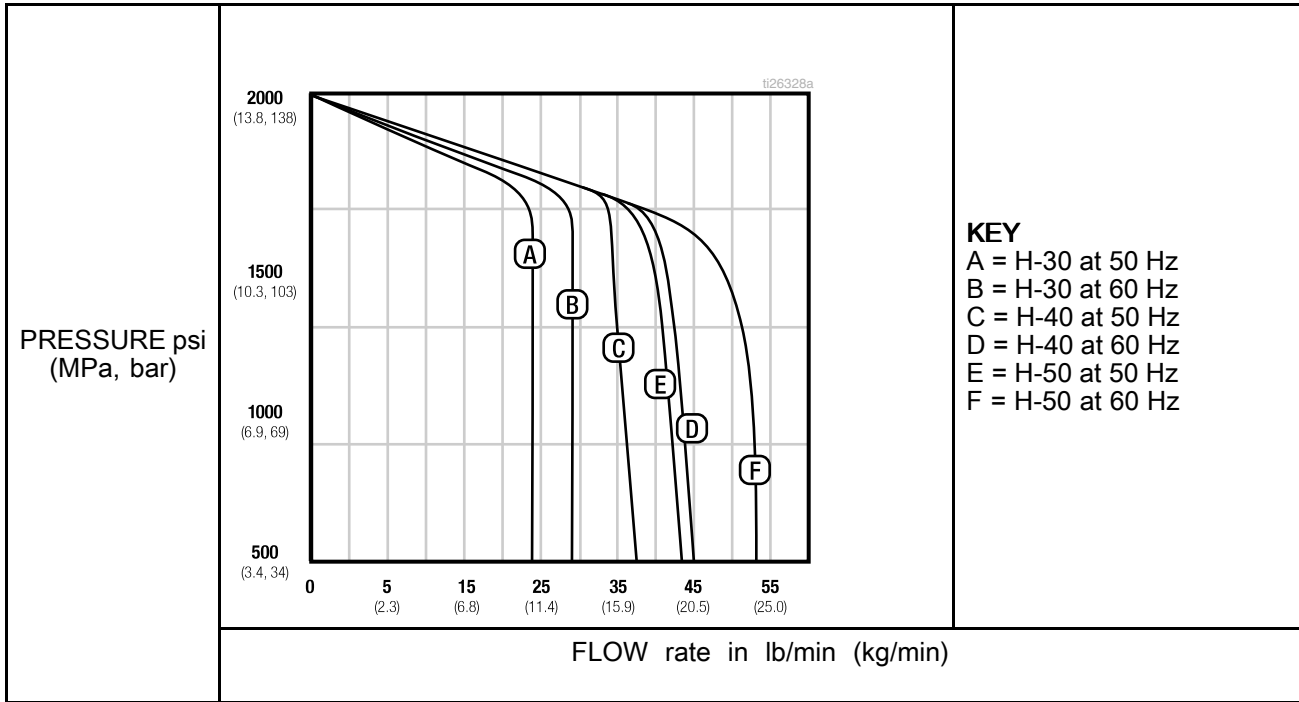

Coatings Performance Chart

Table 8 Coatings Performance Chart

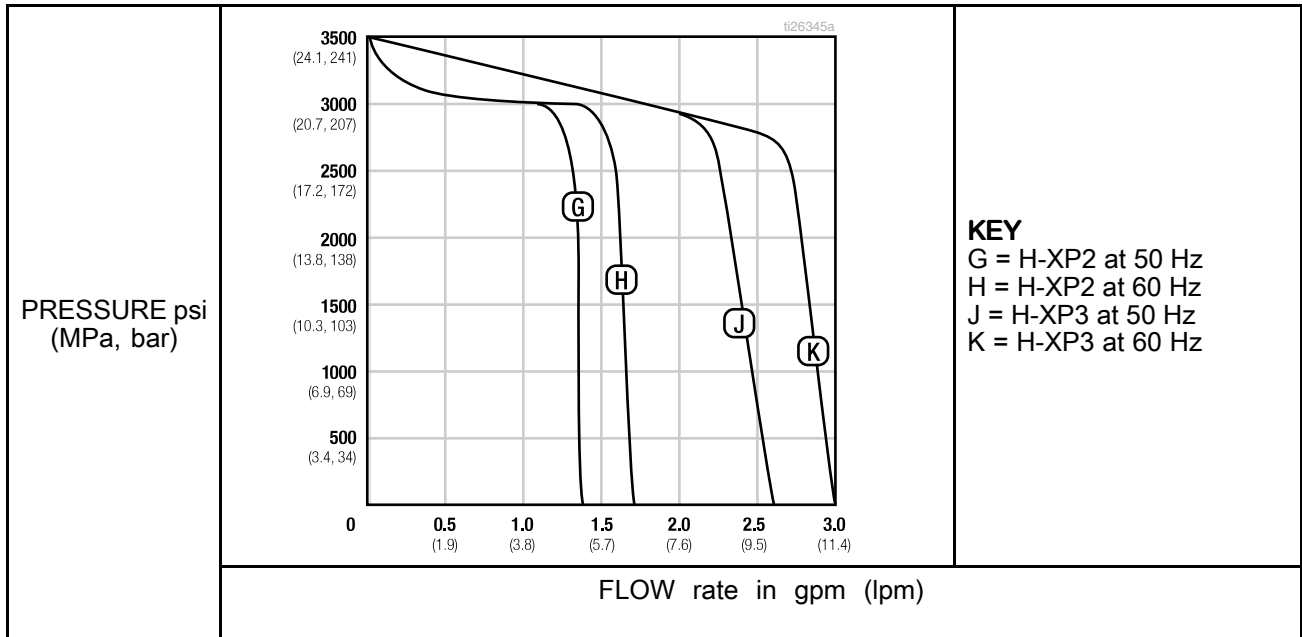

Heater Performance Chart

Table 9 Heater Performance Chart

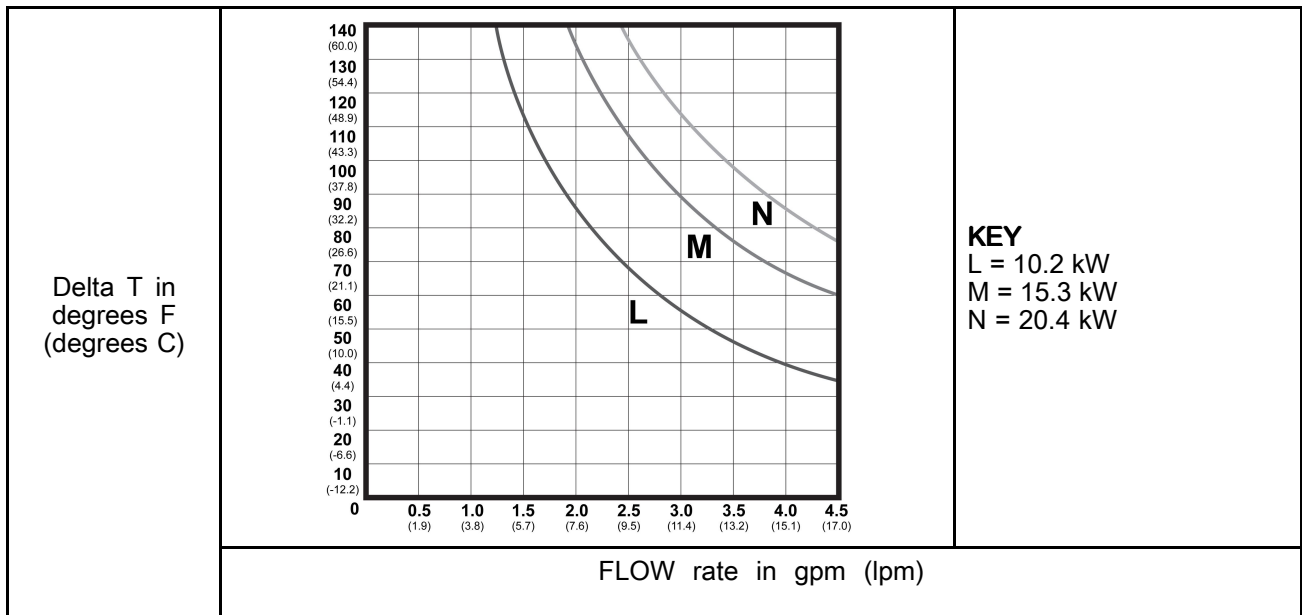

* Heater performance data is based on testing with 10 wt. hydraulic oil and 230V across heater power wires.

Dimensions

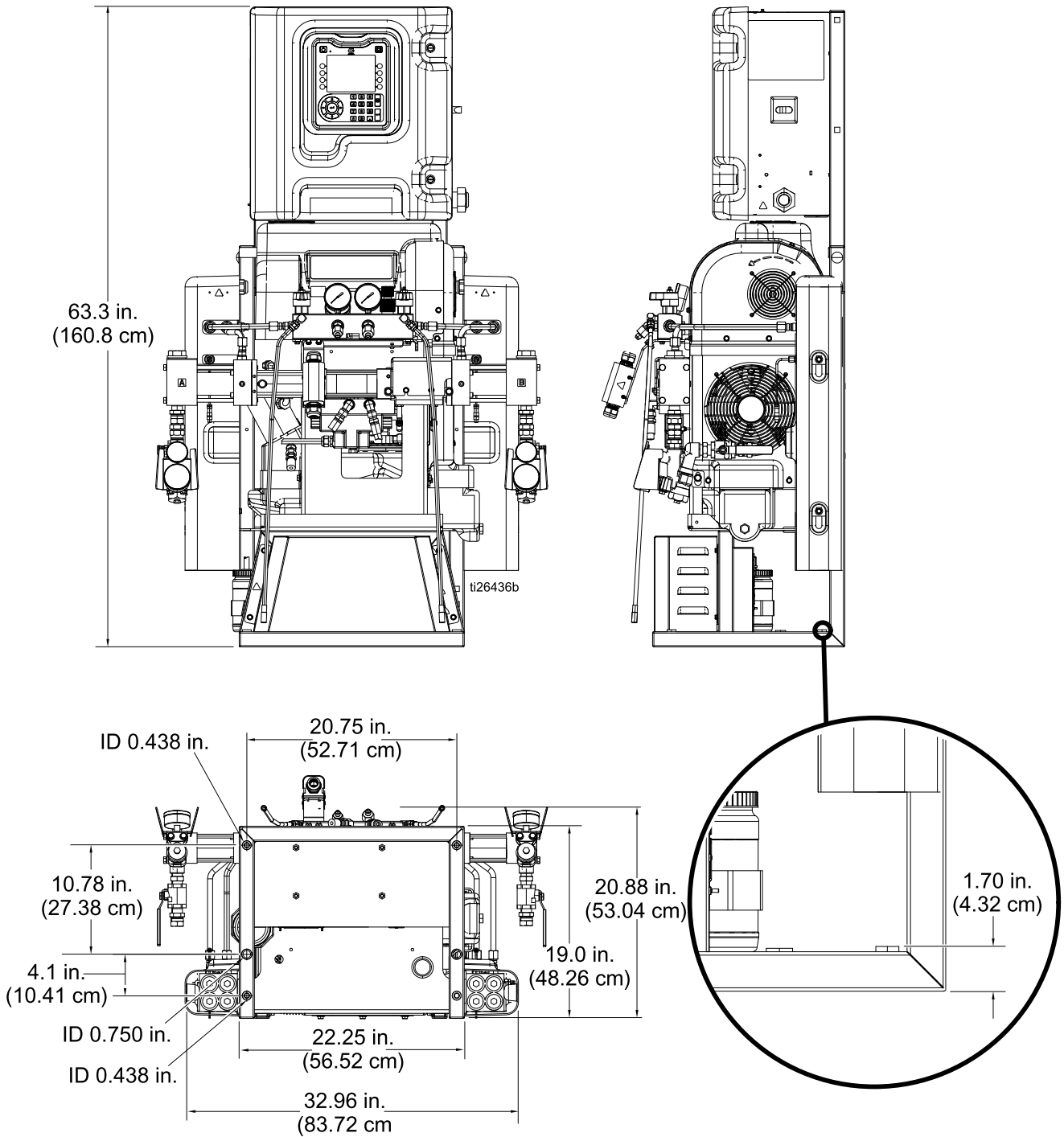

Technical Specifications

Reactor 2 Hydraulic Proportioning System		
	U.S.	Metric
Maximum Fluid Working Pressure for Bare Proportioners		
Models H-30, H-40, and H-50	2000 psi	13.8 MPa, 138 bar
Models H-XP2 and H-XP3	3500 psi	24.1 MPa, 241 bar
Minimum Fluid Working Pressure for Bare Proportioners		
H-30	700 psi	4.8 MPa, 48 bar
H-40, H-50	600 psi	4.1 MPa, 41 bar
H-XP2	1200 psi	8.2 MPa, 82 bar
H-XP3	850 psi	5.8 MPa, 58 bar
Fluid: Oil Pressure Ratio		
Model H-40	1.91 : 1	
Models H-30 and H-50	1.64 : 1	
Models H-XP2 and H-XP3	2.79 : 1	
Fluid Inlets		
Component A (ISO)	3/4 npt(f), 300 psi maximum	3/4 npt(f), 2.07 MPa, 20.7 bar maximum
Component B (RES)	3/4 npt(f), 300 psi maximum	3/4 npt(f), 2.07 MPa, 20.7 bar maximum
Fluid Outlets		
Component A (ISO)	#8 1/2 in. JIC, with #5 5/16 in. JIC adapter	
Component B (RES)	#10 5/8 in. JIC, with #6 3/8 in. JIC adapter	
Fluid Circulation Ports		
1/4 npsm(m)	250 psi	1.75 MPa, 17.5 bar
Maximum Fluid Temperature		
	190° F	88° C
Maximum Output (10 weight oil at ambient temperature)		
Model H-30	28 lb/min (60 Hz)	13 kg/min (60 Hz)
Model H-XP2	1.5 gpm (60 Hz)	5.7 liter/min (60 Hz)
Model H-50	52 lb/min (60 Hz)	24 kg/min (60 Hz)
Model H-40	45 lb/min (60 Hz)	20 kg/min (60 Hz)
Model H-XP3	2.8 gpm (60 Hz)	10.6 liter/min (60 Hz)
Output Per Cycle (A and B)		
Model H-40	0.063 gal.	0.24 liter
Models H-30 and H-50	0.074 gal.	0.28 liter
Models H-XP2 and H-XP3	0.042 gal.	0.16 liter

Supply Voltage Tolerance		
200–240V nominal, 1 phase (H-30, H-XP2 only)	195–264 VAC, 50/60 Hz	
200–240V nominal, 3 phase	195–264 VAC, 50/60 Hz	
350–415V nominal, 3 phase	338–457 VAC, 50/60 Hz	
Amperage Requirement (phase)		
See the Models listing in the manual.		
Heater Power (A and B heaters total)		
See the Models listing in the manual.		
Hydraulic Reservoir Capacity		
	3.5 gal.	13.6 liters
Recommended Hydraulic Fluid		
	Citgo, A/W Hydraulic Oil, ISO Grade 46	
Sound Power, per ISO 9614–2		
	90.2 dB(A)	
Sound Pressure 1 m From Equipment		
	82.6 dB(A)	
Weight		
H-40, H-50, H-XP3,	600 lb	272 kg
H-30, 10 kW	544 lb	247 kg
H-30, H-XP2, 15 kW	556 lb	252 kg
Wetted Parts		
	Aluminum, stainless steel, zinc-plated carbon steel, brass, carbide, chrome, fluoroelastomer, PTFE, ultra-high molecular weight polyethylene, chemically resistant o-rings	
<i>All other brand names or marks are used for identification purposes and are trademarks of their respective owners.</i>		

Graco Extended Warranty

Graco warrants all equipment referenced in this document which is manufactured by Graco and bearing its name to be free from defects in material and workmanship on the date of sale to the original purchaser for use. Graco will, for a period as defined in the table below from the date of sale, repair or replace any part of the equipment determined by Graco to be defective. This warranty applies only when the equipment is installed, operated and maintained in accordance with Graco's written recommendations.

Part	Description	Warranty Period
24U854	Advanced Display Module	36 Months or 2 Million Cycles (whichever comes first)
24Y263	Hydraulic Control Module	36 Months or 2 Million Cycles (whichever comes first)
24U855	Temperature Control Module	36 Months or 2 Million Cycles (whichever comes first)
All Other Parts		12 Months

This warranty does not cover, and Graco shall not be liable for general wear and tear, or any malfunction, damage or wear caused by faulty installation, misapplication, abrasion, corrosion, inadequate or improper maintenance, negligence, accident, tampering, or substitution of non-Graco component parts. Nor shall Graco be liable for malfunction, damage or wear caused by the incompatibility of Graco equipment with structures, accessories, equipment or materials not supplied by Graco, or the improper design, manufacture, installation, operation or maintenance of structures, accessories, equipment or materials not supplied by Graco.

This warranty is conditioned upon the prepaid return of the equipment claimed to be defective to an authorized Graco distributor for verification of the claimed defect. If the claimed defect is verified, Graco will repair or replace free of charge any defective parts. The equipment will be returned to the original purchaser transportation prepaid. If inspection of the equipment does not disclose any defect in material or workmanship, repairs will be made at a reasonable charge, which charges may include the costs of parts, labor, and transportation.

THIS WARRANTY IS EXCLUSIVE, AND IS IN LIEU OF ANY OTHER WARRANTIES, EXPRESS OR IMPLIED, INCLUDING BUT NOT LIMITED TO WARRANTY OF MERCHANTABILITY OR WARRANTY OF FITNESS FOR A PARTICULAR PURPOSE.

Graco's sole obligation and buyer's sole remedy for any breach of warranty shall be as set forth above. The buyer agrees that no other remedy (including, but not limited to, incidental or consequential damages for lost profits, lost sales, injury to person or property, or any other incidental or consequential loss) shall be available. Any action for breach of warranty must be brought within two (2) years of the date of sale.

GRACO MAKES NO WARRANTY, AND DISCLAIMS ALL IMPLIED WARRANTIES OF MERCHANTABILITY AND FITNESS FOR A PARTICULAR PURPOSE, IN CONNECTION WITH ACCESSORIES, EQUIPMENT, MATERIALS OR COMPONENTS SOLD BUT NOT MANUFACTURED BY GRACO.

These items sold, but not manufactured by Graco (such as electric motors, switches, hose, etc.), are subject to the warranty, if any, of their manufacturer. Graco will provide purchaser with reasonable assistance in making any claim for breach of these warranties.

In no event will Graco be liable for indirect, incidental, special or consequential damages resulting from Graco supplying equipment hereunder, or the furnishing, performance, or use of any products or other goods sold hereto, whether due to a breach of contract, breach of warranty, the negligence of Graco, or otherwise.

FOR GRACO CANADA CUSTOMERS

The Parties acknowledge that they have required that the present document, as well as all documents, notices and legal proceedings entered into, given or instituted pursuant hereto or relating directly or indirectly hereto, be drawn up in English. Les parties reconnaissent avoir convenu que la rédaction du présente document sera en Anglais, ainsi que tous documents, avis et procédures judiciaires exécutés, donnés ou intentés, à la suite de ou en rapport, directement ou indirectement, avec les procédures concernées.

Graco Information

For the latest information about Graco products, visit www.graco.com.

For patent information, see www.graco.com/patents.

To place an order, contact your Graco Distributor or call to identify the nearest distributor.

Phone: 612-623-6921 **or Toll Free:** 1-800-328-0211 **Fax:** 612-378-3505

All written and visual data contained in this document reflects the latest product information available at the time of publication.

Graco reserves the right to make changes at any time without notice.

Original Instructions. This manual contains English. MM **334945**

Graco Headquarters: Minneapolis

International Offices: Belgium, China, Japan, Korea

GRACO INC. AND SUBSIDIARIES • P.O. BOX 1441 • MINNEAPOLIS MN 55440-1441 • USA

Copyright 2014, Graco Inc. All Graco manufacturing locations are registered to ISO 9001.

www.graco.com

Revision G, August 2019